

PL6302M PL6302P PL6302MP

(Datasheet)

Type	WiFi/Bluetooth antenna
Frequencies	WIFI / BLUETOOTH (2.4 GHz) WiFi (5.1 – 5.9 GHz)
Mounting	M - Magnetic mount P - Patch mount
Revision	00

A handwritten signature in black ink, appearing to read "D. Noble".

D. Noble



1. PRODUCT SELECTOR

PL6302P	Patch mount
PL6302M	Magnetic mount
PL6302MP	Magnetic mount with sticker for patch mount

2. SPECIFICATION

2.1. Electrical Specifications

Frequencies	WIFI / BLUETOOTH (2.4 GHz) WIFI (5.1 – 5.9 GHz)
Impedance	50 Ohms
Polarization	Linear
Gain	2.4GHz: 2dBi / 5GHz: 5dBi
VSWR*	<2.5:1
Cable length	min 30cm
Operating temperature	-40°C to +85°C

2.2. Connection Specifications

Connector type:	SMA male
Cable:	RG174U
Cable length:	30 cm

2.3. Mechanical Specifications and Dimensions

Material:	ABS
Dimensions:	52.5mm x 14.3mm 52.5mm x 13.1mm (without sticker)
Colour:	Black (for different colours please ask our sales team)

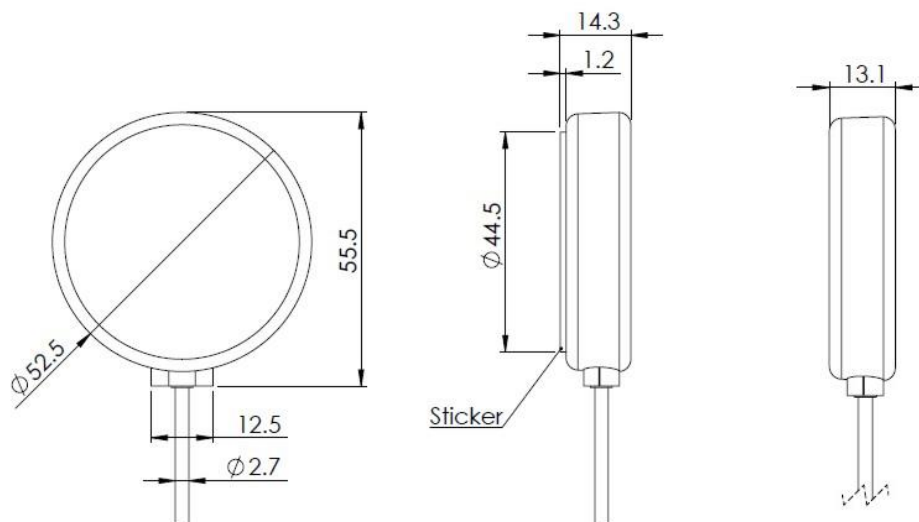

3. MEASUREMENT

VSWR

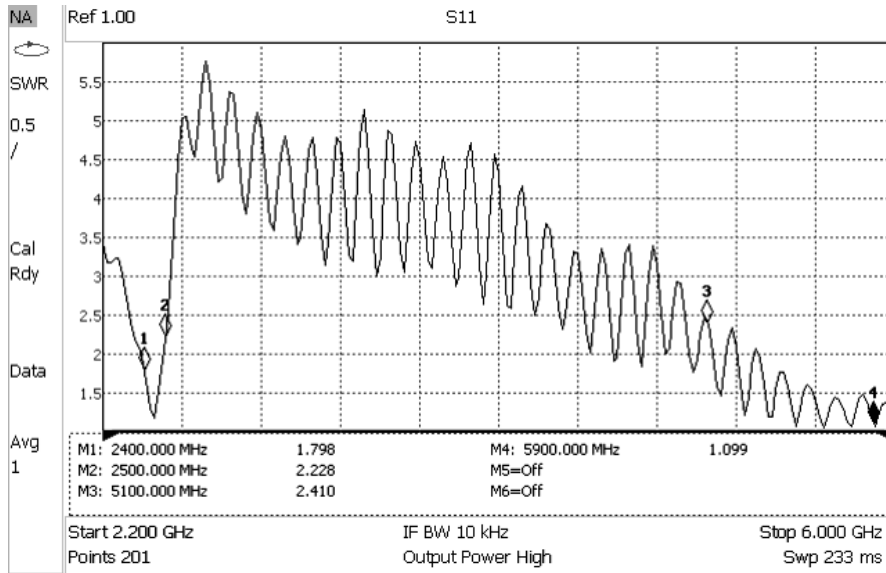

Freq = 2.4002GHz Az= 45 EL= 45

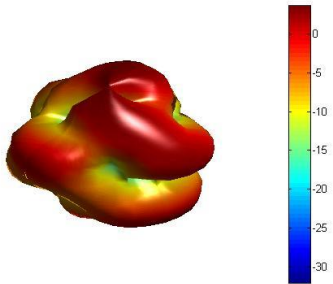

Freq = 5.0972GHz Az= 45 EL= 45

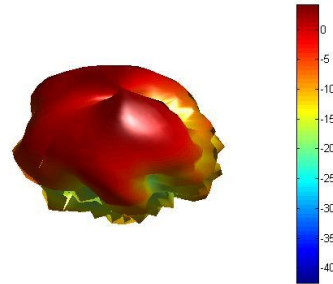

Freq = 5.3147GHz Az= 45 EL= 45

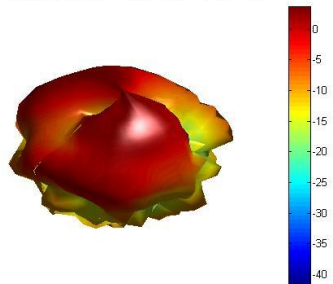

Freq = 5.6192GHz Az= 45 EL= 45

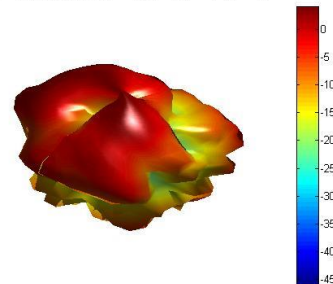

Freq = 5.902GHz Az= 45 EL= 45

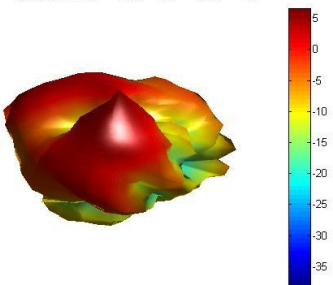

4. PICTURES

