

Security Level:

HUAWEI LGA Module PCB Design Guide

www.huawei.com

Author: HUAWEI M2M Team

Version: V2.0

Data: 2015-02-02

HUAWEI TECHNOLOGIES CO., LTD.





Copyright © Huawei Technologies Co., Ltd. 2015. All rights reserved.

No part of this manual may be reproduced or transmitted in any form or by any means without prior written consent of Huawei Technologies Co., Ltd. and its affiliates ("Huawei").

The product described in this manual may include copyrighted software of Huawei and possible licensors. Customers shall not in any manner reproduce, distribute, modify, decompile, disassemble, decrypt, extract, reverse engineer, lease, assign, or sublicense the said software, unless such restrictions are prohibited by applicable laws or such actions are approved by respective copyright holders.

Trademarks and Permissions

 , HUAWEI, and  are trademarks or registered trademarks of Huawei Technologies Co., Ltd. LTE is a trade mark of ETSI.

Other trademarks, product, service and company names mentioned may be the property of their respective owners.

Notice

Some features of the product and its accessories described herein rely on the software installed, capacities and settings of local network, and therefore may not be activated or may be limited by local network operators or network service providers.

Thus, the descriptions herein may not exactly match the product or its accessories which you purchase.

Huawei reserves the right to change or modify any information or specifications contained in this manual without prior notice and without any liability.

DISCLAIMER

ALL CONTENTS OF THIS MANUAL ARE PROVIDED "AS IS". EXCEPT AS REQUIRED BY APPLICABLE LAWS, NO WARRANTIES OF ANY KIND, EITHER EXPRESS OR IMPLIED, INCLUDING BUT NOT LIMITED TO, THE IMPLIED WARRANTIES OF MERCHANTABILITY AND FITNESS FOR A PARTICULAR PURPOSE, ARE MADE IN RELATION TO THE ACCURACY, RELIABILITY OR CONTENTS OF THIS MANUAL.

TO THE MAXIMUM EXTENT PERMITTED BY APPLICABLE LAW, IN NO EVENT SHALL HUAWEI BE LIABLE FOR ANY SPECIAL, INCIDENTAL, INDIRECT, OR CONSEQUENTIAL DAMAGES, OR LOSS OF PROFITS, BUSINESS, REVENUE, DATA, GOODWILL SAVINGS OR ANTICIPATED SAVINGS REGARDLESS OF WHETHER SUCH LOSSES ARE FORSEEABLE OR NOT.

THE MAXIMUM LIABILITY (THIS LIMITATION SHALL NOT APPLY TO LIABILITY FOR PERSONAL INJURY TO THE EXTENT APPLICABLE LAW PROHIBITS SUCH A LIMITATION) OF HUAWEI ARISING FROM THE USE OF THE PRODUCT DESCRIBED IN THIS MANUAL SHALL BE LIMITED TO THE AMOUNT PAID BY CUSTOMERS FOR THE PURCHASE OF THIS PRODUCT.

Import and Export Regulations

Customers shall comply with all applicable export or import laws and regulations and be responsible to obtain all necessary governmental permits and licenses in order to export, re-export or import the product mentioned in this manual including the software and technical data therein.

Privacy Policy

To better understand how we protect your personal information, please see the privacy policy at <http://consumer.huawei.com/privacy-policy>.

Revision History

Document Version	Date	Chapter	Descriptions
V1.0	2014-11-10		Creation
V2.0	2015-02-02	Ground Pad	Updated [GND Recommendation2] to [GND Rule1]

Contents

- PCB Stack
- Antenna Pad
- RF Signal
- Power Pad
- Ground Pad
- USB Signal
- Audio Signal
- Low Speed Digital Signal (such as UART/JTAG/PCM)
- ESD Protection
- SIM Card Interface

PCB Stack

[Recommendation] For 1 mm PCB, four layers and six layers PCB stack are recommended as follows:

1.0mm 4layers		PCB Stack	One electroplate, one press		
			Finished (mil)	Tolerance(mil)	Er
Top mask			0.8		
L1	Copper(HOZ+plating)		1.8		
	prepreg 7628		8.2		
L2	Copper(base)1OZ		1.2		
	core		15.7		
L3	Copper(base)1OZ		1.2		
	prepreg 7628		8.2		
L4	Copper(HOZ+plating)		1.8		
Bottom mask			0.8		
Final Total			39.7		
			1.01		

1.0mm 6layers		PCB Stack	One electroplate, one press		
			Finished(mil)	Tolerance(mil)	Er
Top mask			0.8		
L1	Copper(HOZ+plating)		1.8		
	prepreg 2116		4.5		
L2	Copper(base)1OZ		1.2		
	Core		7.9		
L3	Copper(base)1OZ		1.2		
	prepreg 2116		4.5		
L4	Copper(base)1OZ		1.2		
	Core		7.9		
L5	Copper(base)1OZ		1.2		
	prepreg 2116		4.5		
L6	Copper(HOZ+plating)		1.8		
Bottom mask			0.8		
Final Total			39.3		
			1.00		

Antenna Pad (30 mm*30 mm LGA)

MU509 series and MC509

Antenna pads are big and in the inner circle, so the antenna signal should be inner trace and via the hole in the PCB layout.

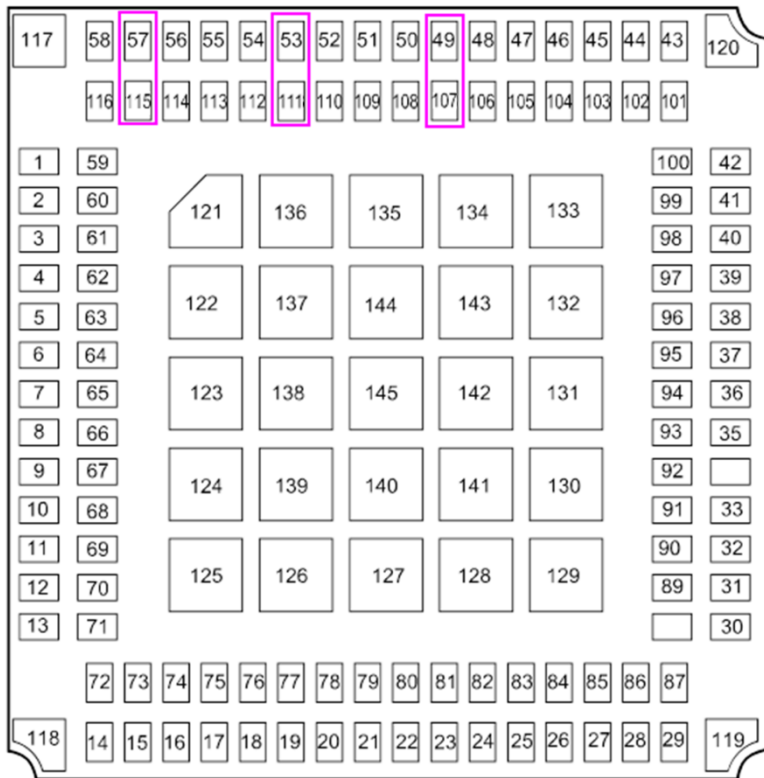

MU609, ME909u-521

Antenna pads are small and in the inner circle, so the antenna signal should be inner trace and via the hole in the PCB layout.

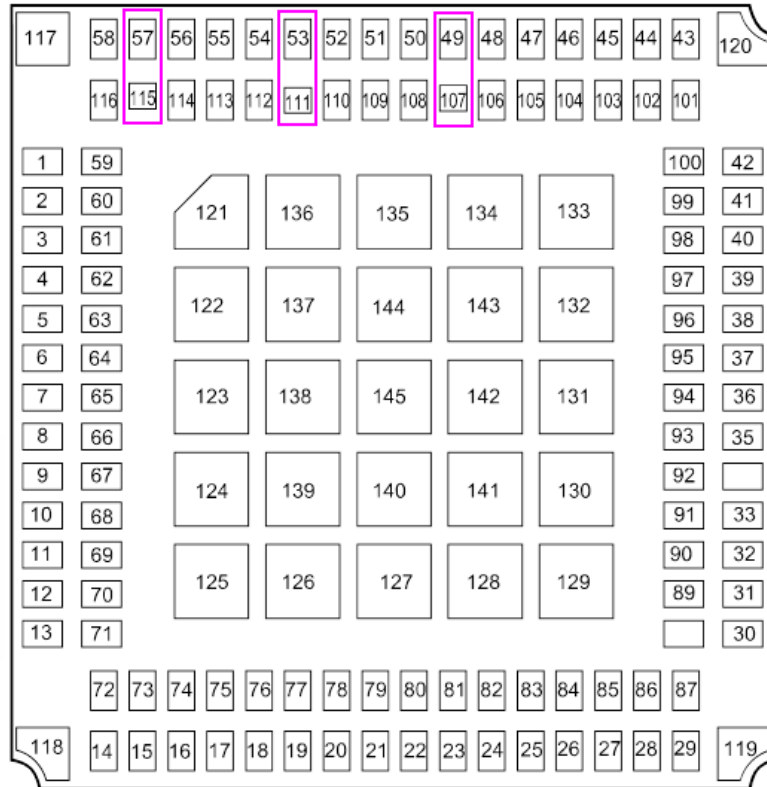

ME909u-523/later modules

Antenna pads are small, and Pin 57, 53 and 49 are deleted, so the antenna signal can be surface trace.

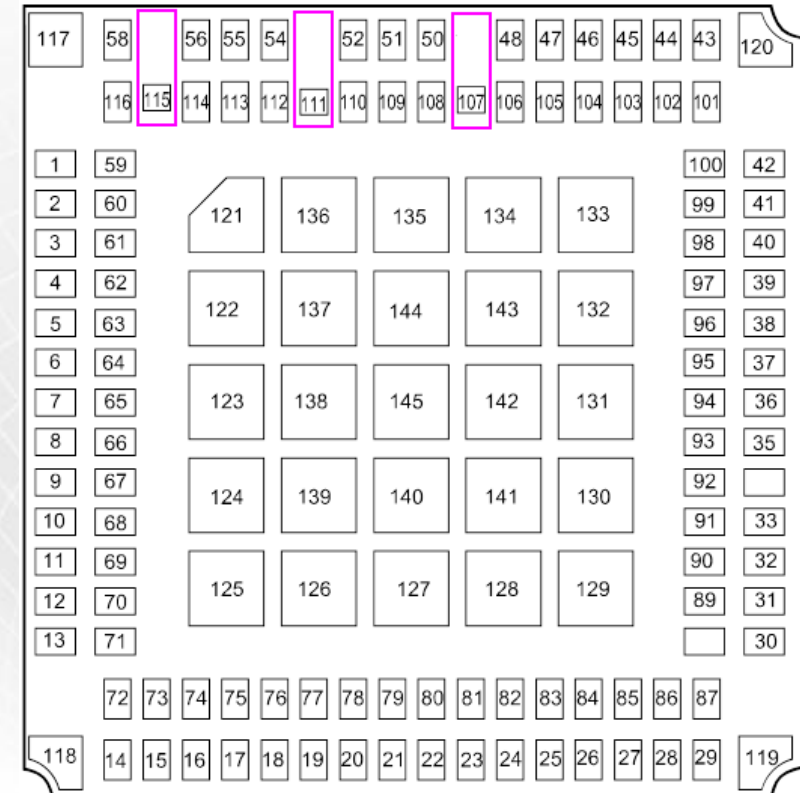

RF Signal

[RF Rule1] For boards that have more than two layers, empty part of the adjacent layer below the RF pad.

Emptying method: Empty the copper sheet of the adjacent lower layer. The area to empty is 30 mils larger than the RF pad.

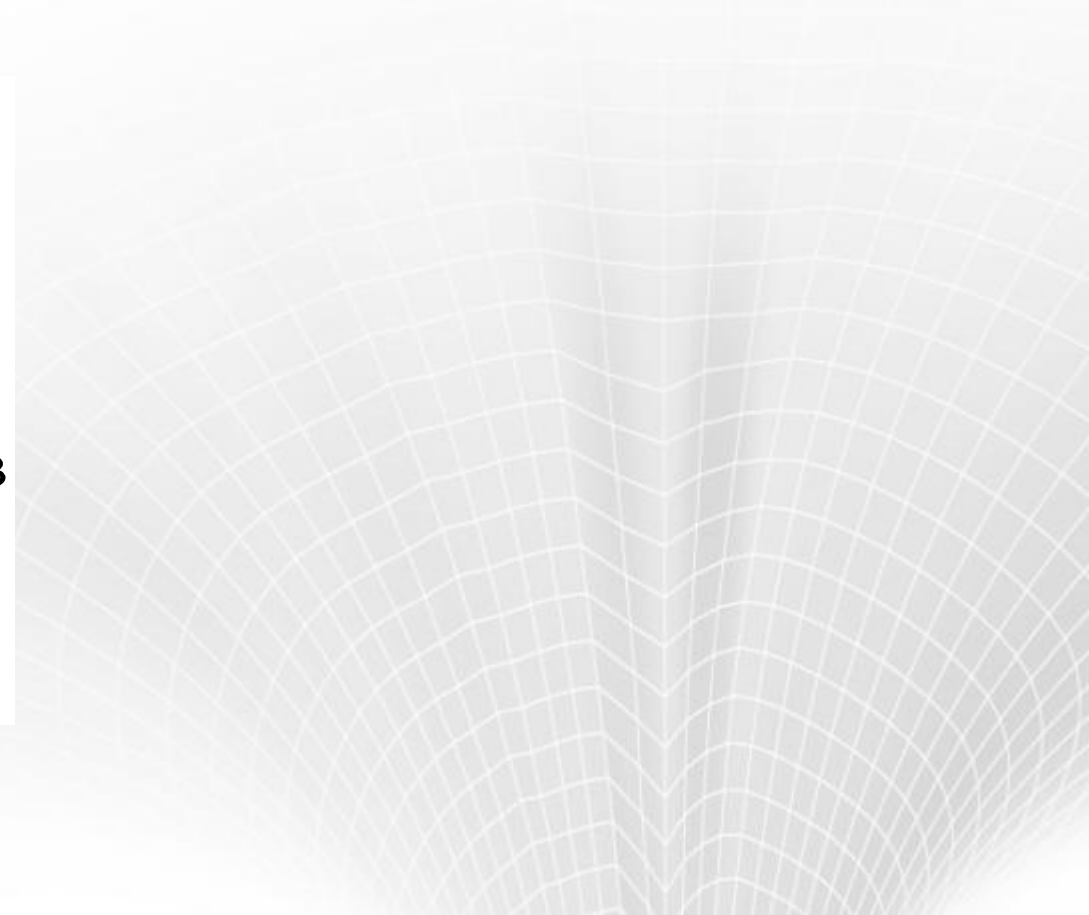
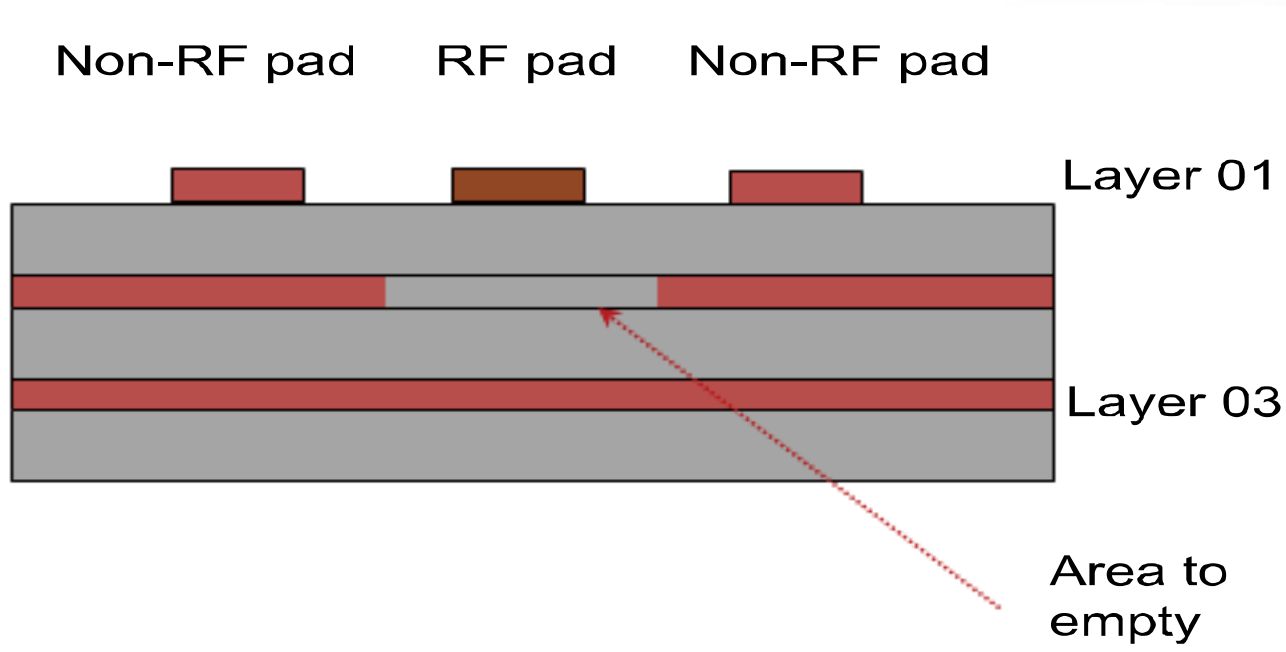

RF Signal

[RF Rule2] The recommended distance between the RF pad and copper sheet in the same layer is 15 mils.

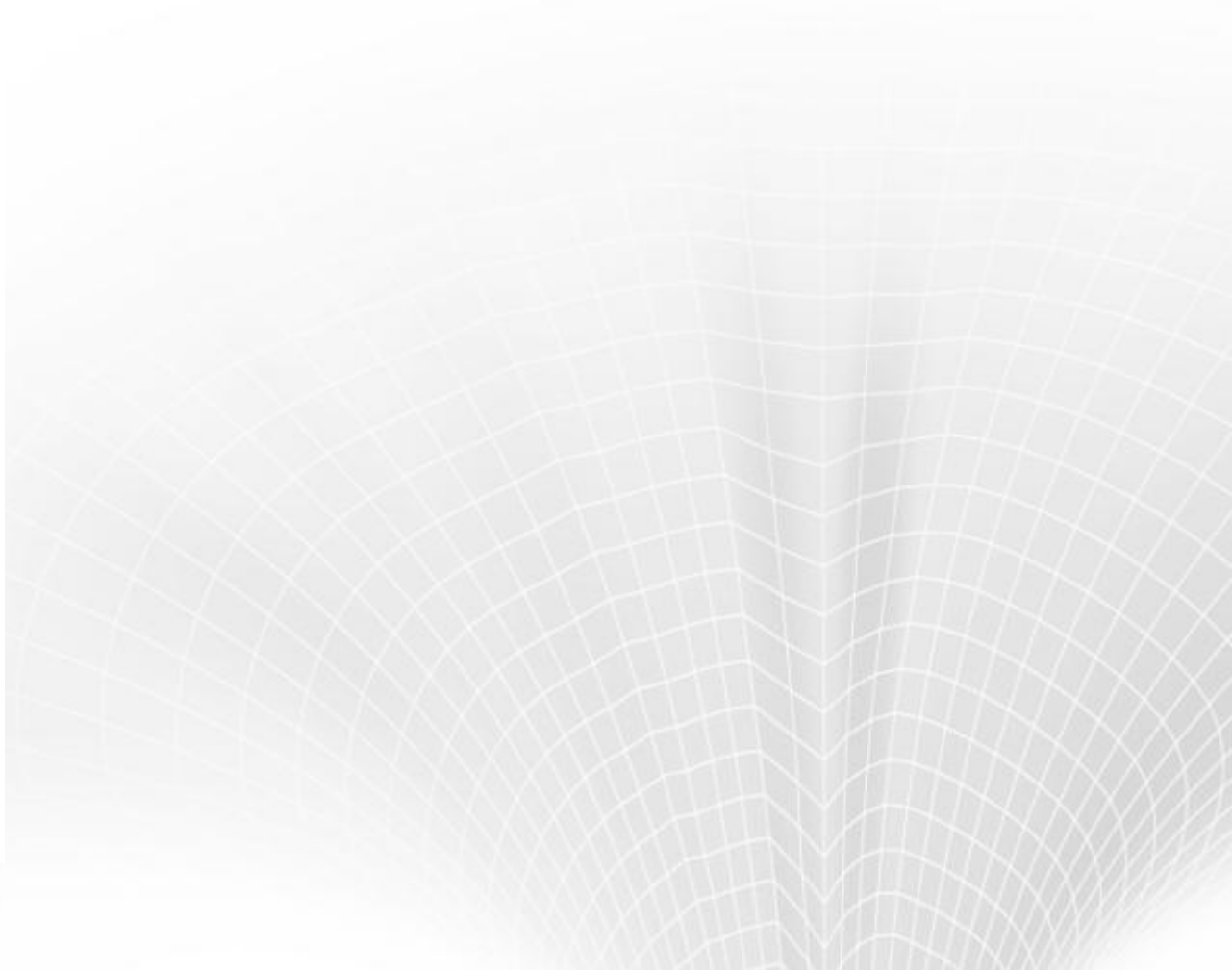
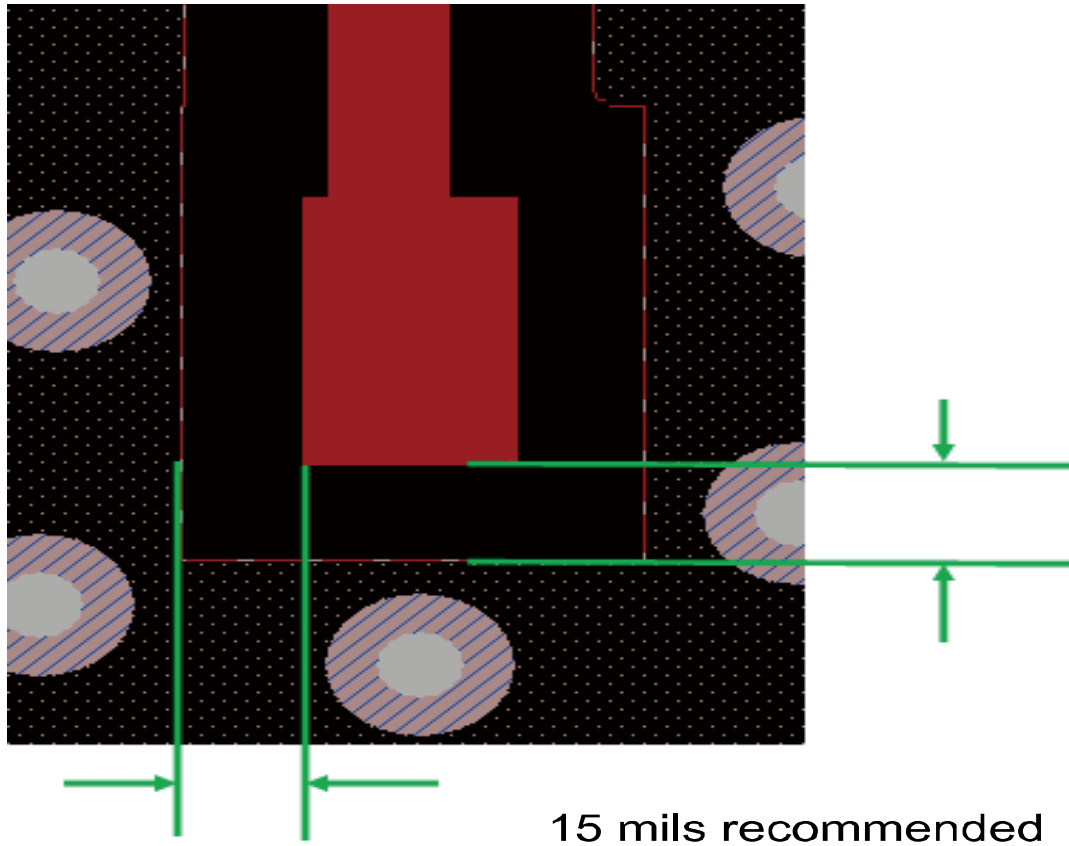

RF Signal

[RF Rule3] The impedance of the trace between the RF pad and antenna is 50 ± 5 ohm.

[RF Rule4] Separate RF signals and other signals using ground copper sheets with holes.

[RF Recommendation1] Make the trace between the RF pad and antenna (or antenna connector) as short and wide as possible to reduce insertion loss.

[RF Recommendation2] Route the RF trace along the surface layer to reduce insertion loss.

[RF Recommendation3] The recommended distance between the RF pad and copper sheet in the same layer is twice the thickness of the medium.

[RF Recommendation4] The matching components of antenna (or antenna connector) should be placed close to the antenna.

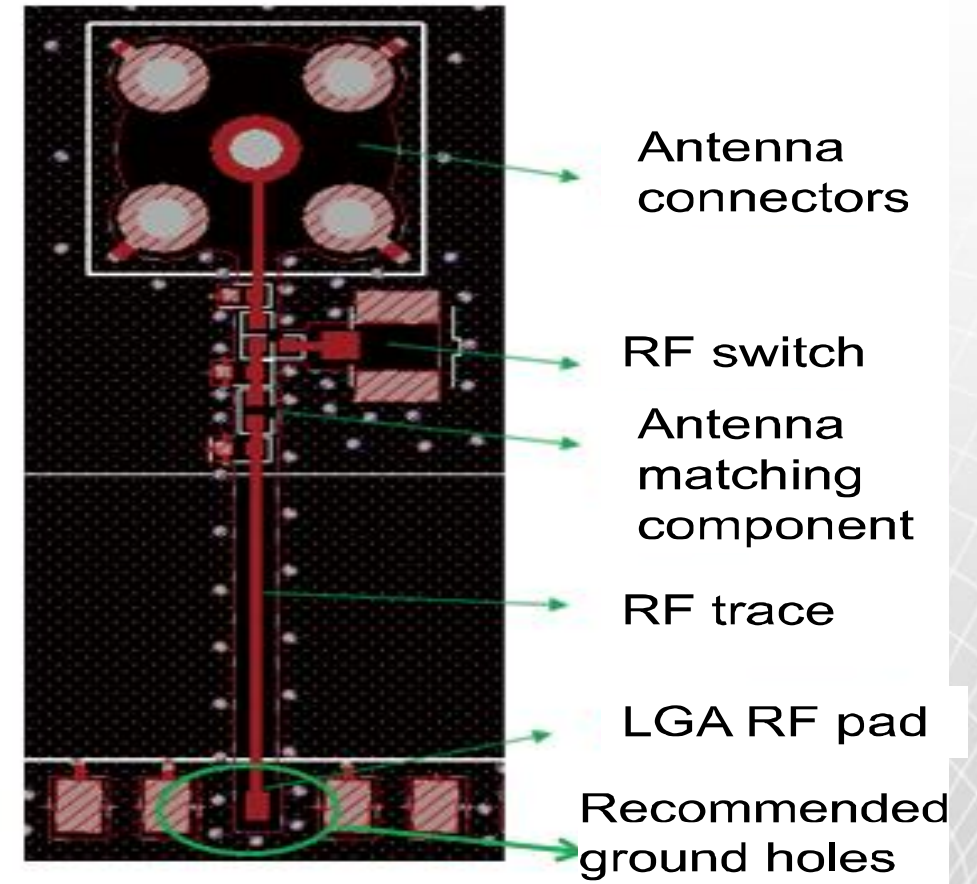

RF Signal

[RF Recommendation5] For SMA connectors, the distance between the RF pad and surrounding sheet is 100 mils. And the ground holes are well-distributed around.

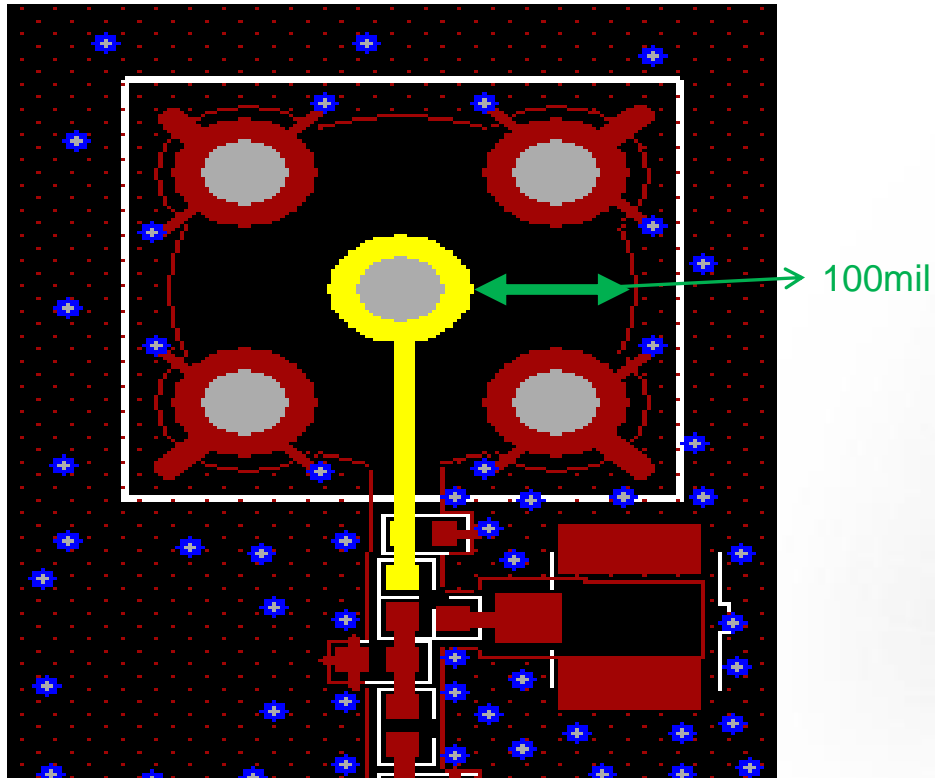

RF Signal Trace for MU509 series/MC509

Firstly, trace out to the other layer, and then trace on the surface.

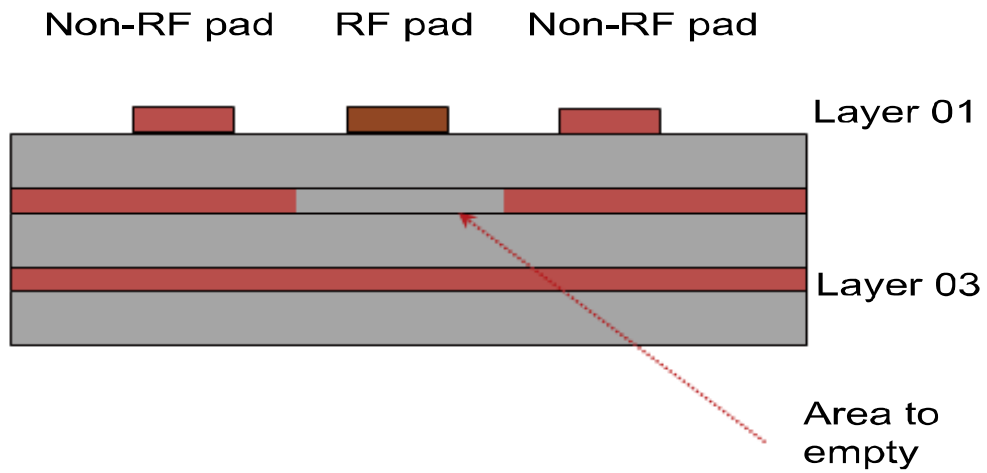

Layer01



Ground hole

Layer02

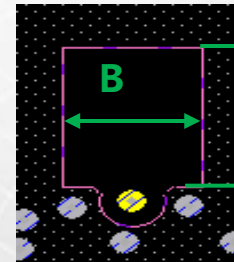

A= RF pad length +30mil

B= RF pad width +30mil

Layer03

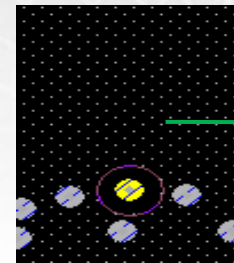

RF pad reference ground

RF Signal Trace for MU609/ME909u-521

To be compatible with the design of MU509, the PCB design of MU609/ME909u-521 can totally refer that of MU509. Firstly, trace out to the other layer, and then trace on the surface.

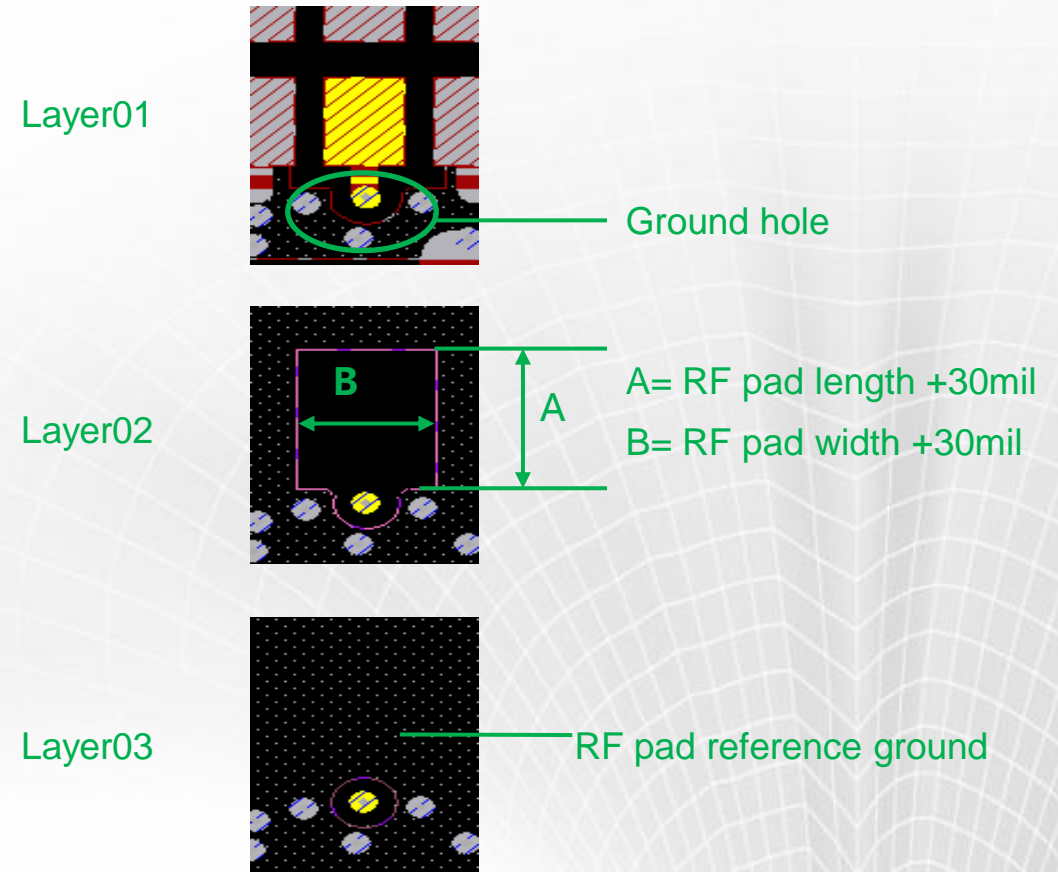
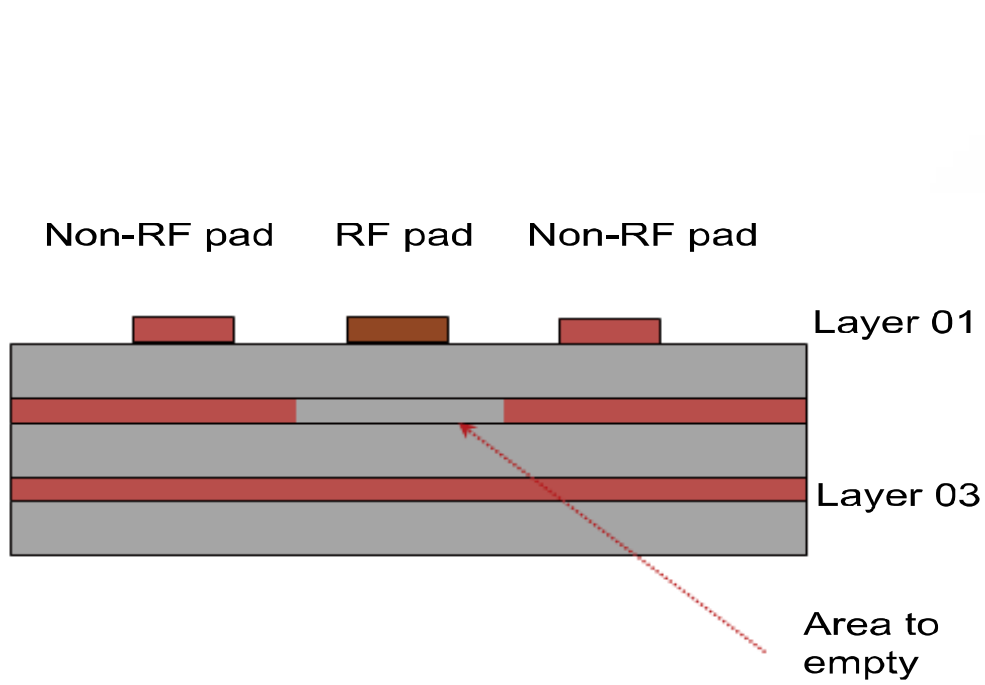

RF Signal Trace for MU709/ME909u-523/Later Modules

1. If you want to be compatible with the design of previous modules, the PCB design can totally refer that of MU509.
2. If you want to be compatible with the design of later modules, it is recommended to use surface trace.

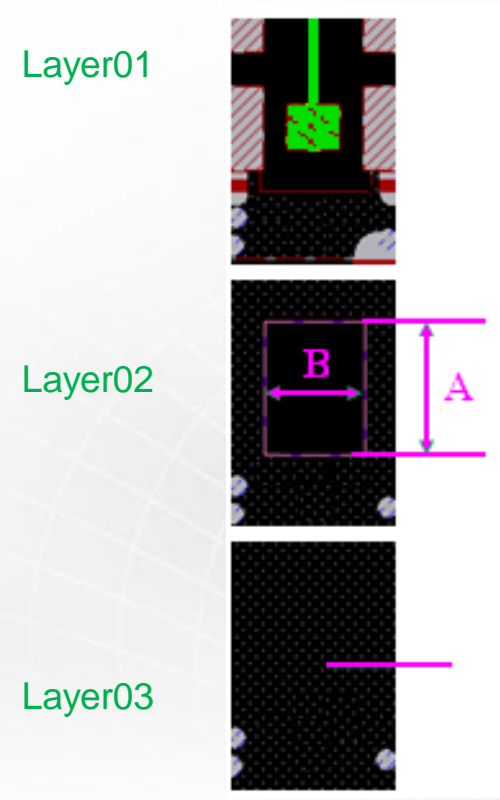
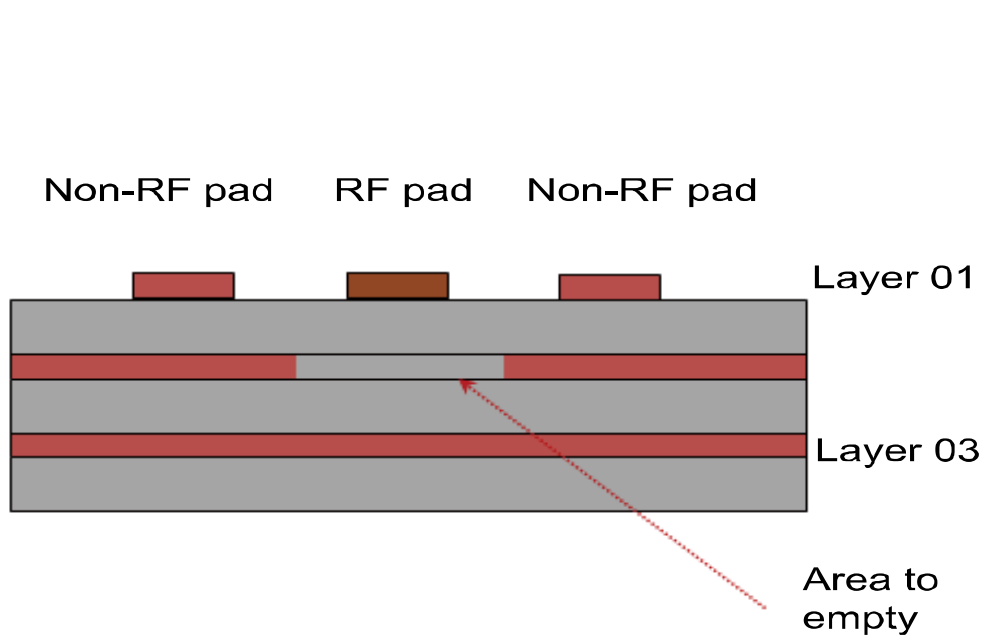

A= RF pad length +50mil
B= RF pad width +40mil

RF pad reference ground

Power Pad

[Power Recommendation1] Place small capacitors near power pins as much as possible.

[Power Recommendation2] 40 mils 1 A power traces.

[Power Recommendation3] Each hole in the power trace allows 0.5 A current.

[Power Recommendation4] Big power pad traces on the single side, and the width of trace is not wider than that of pad, shown as the following figure.

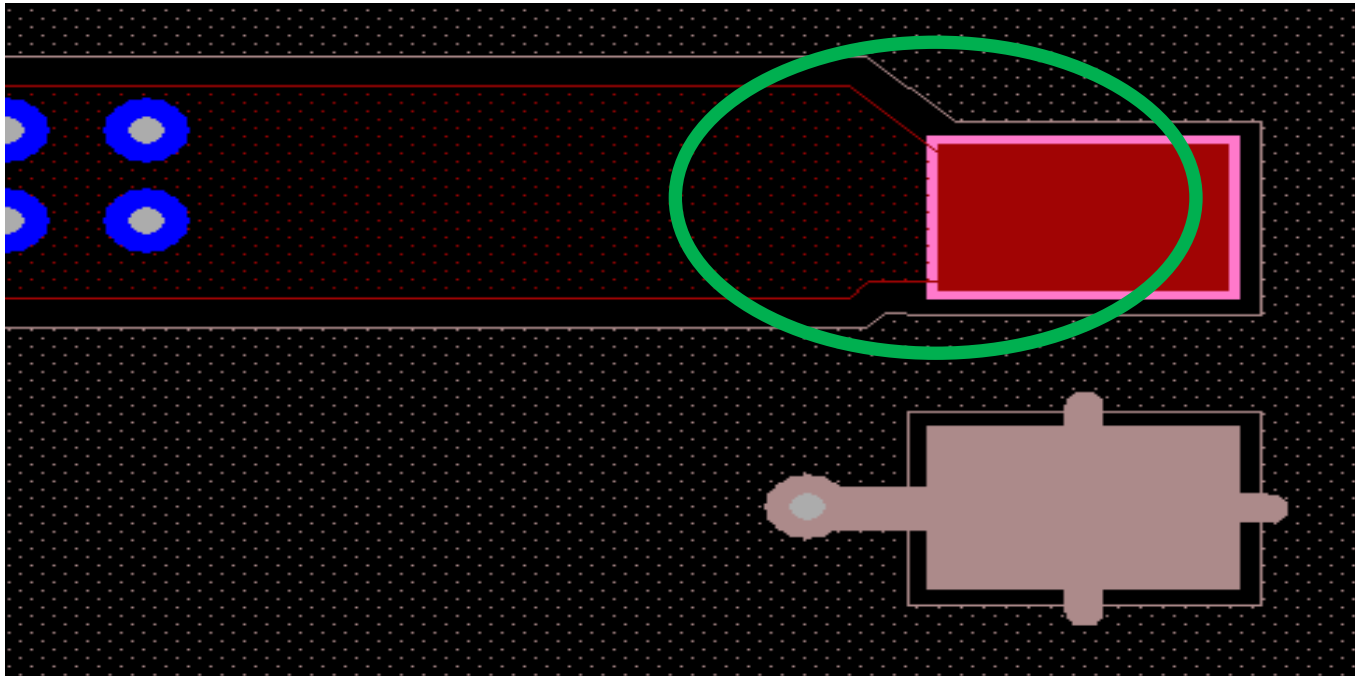

Ground Pad

[GND Recommendation1] Use thermal pad connectors for the ground signal pad with connecting cables 10 mils wide to facilitate welding.

[GND Rule1] Holes are drilled near the thermal pad as much as possible.

[GND Recommendation2] Use thermal pad connectors for the ground thermal pad with connecting cables 40 mils.

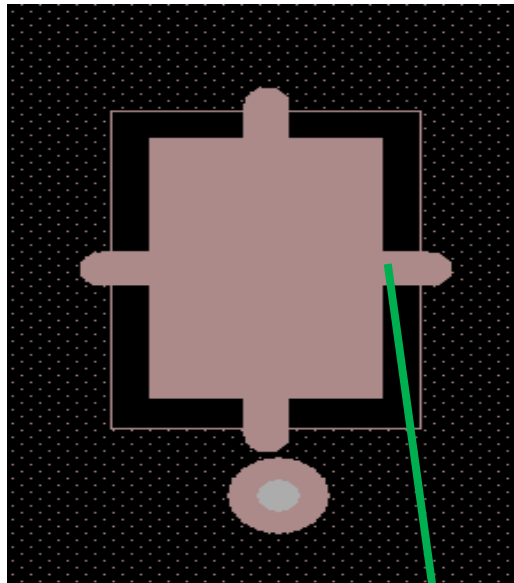

10mil

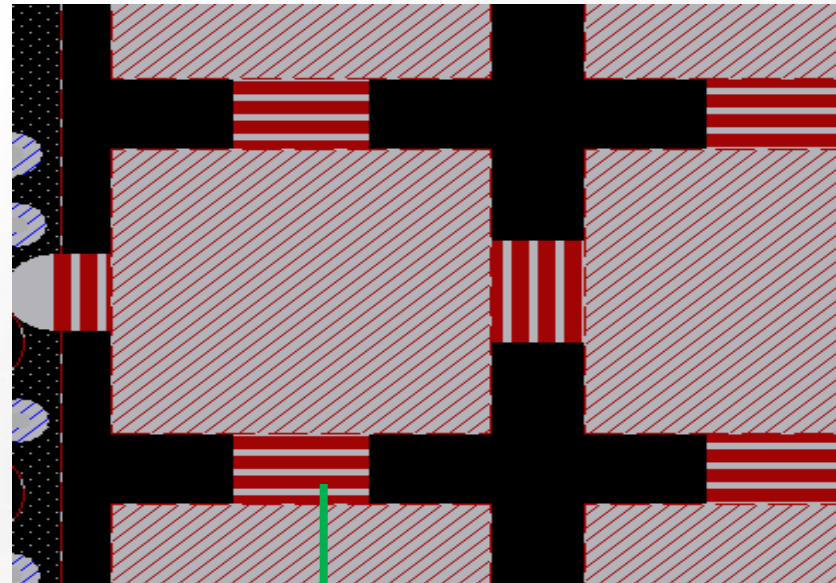

40mil

USB Signal

[USB Rule1] The impedance difference of USB signals is $90 \pm 10\%$ ohm.

[USB Recommendation1] For boards that have more than two layers, empty part of the adjacent layer below the USB pad.

Emptying method: Empty the copper sheet of the adjacent lower layer. The area to empty is 15 mils larger than the USB pad.

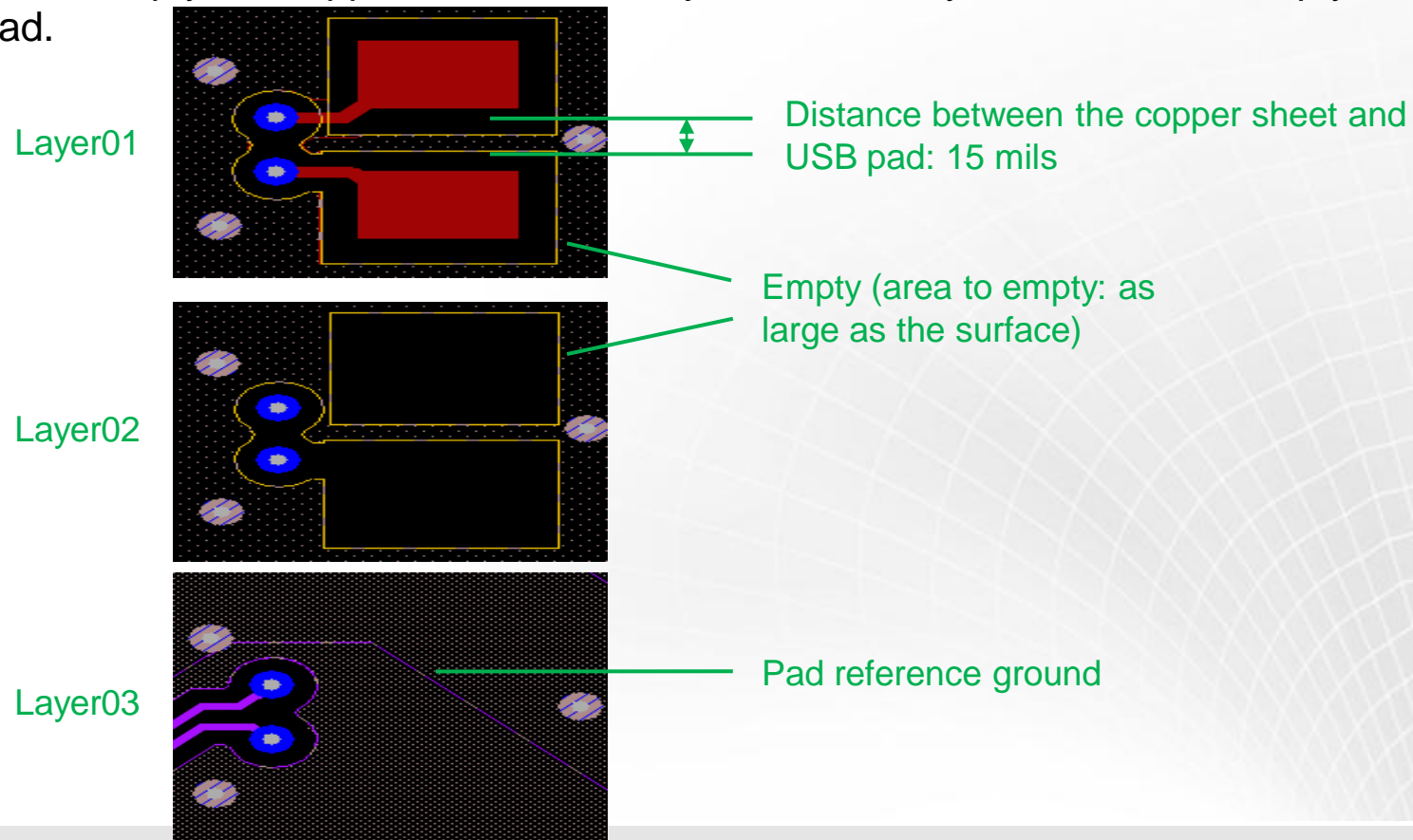

USB Signal

[USB Recommendation2] Route the USB trace along the PCB inside to reduce interference to wireless performance.

[USB Recommendation3] Provide a complete reference ground for USB signals. Drill reflow holes near the interlayer holes. The distance between the USB trace and copper sheet at the same layer is 10 mils.

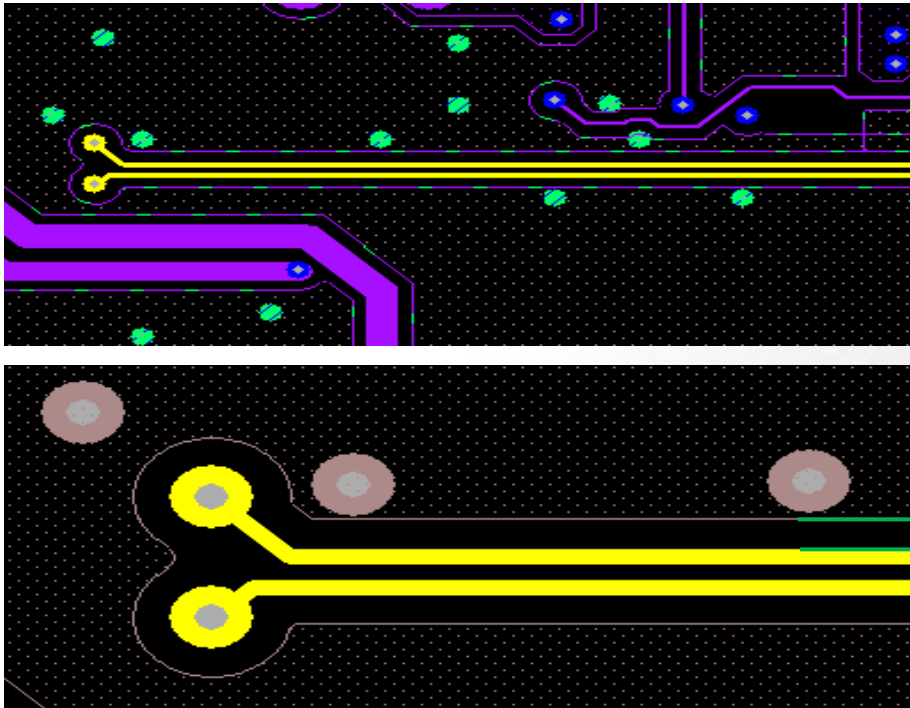

Grounded signal, with reflow
holes 10 mils

10mil

Audio Signal

[Audio Rule1] Connect audio traces to the ground and route them in groups. Isolate the groups after grounding.

[Audio Rule2] The audio signal of LGA modules is differential structure, so route the audio trace as differential groups.

[Audio Recommendation1] Route the audio trace away from other digital signals.

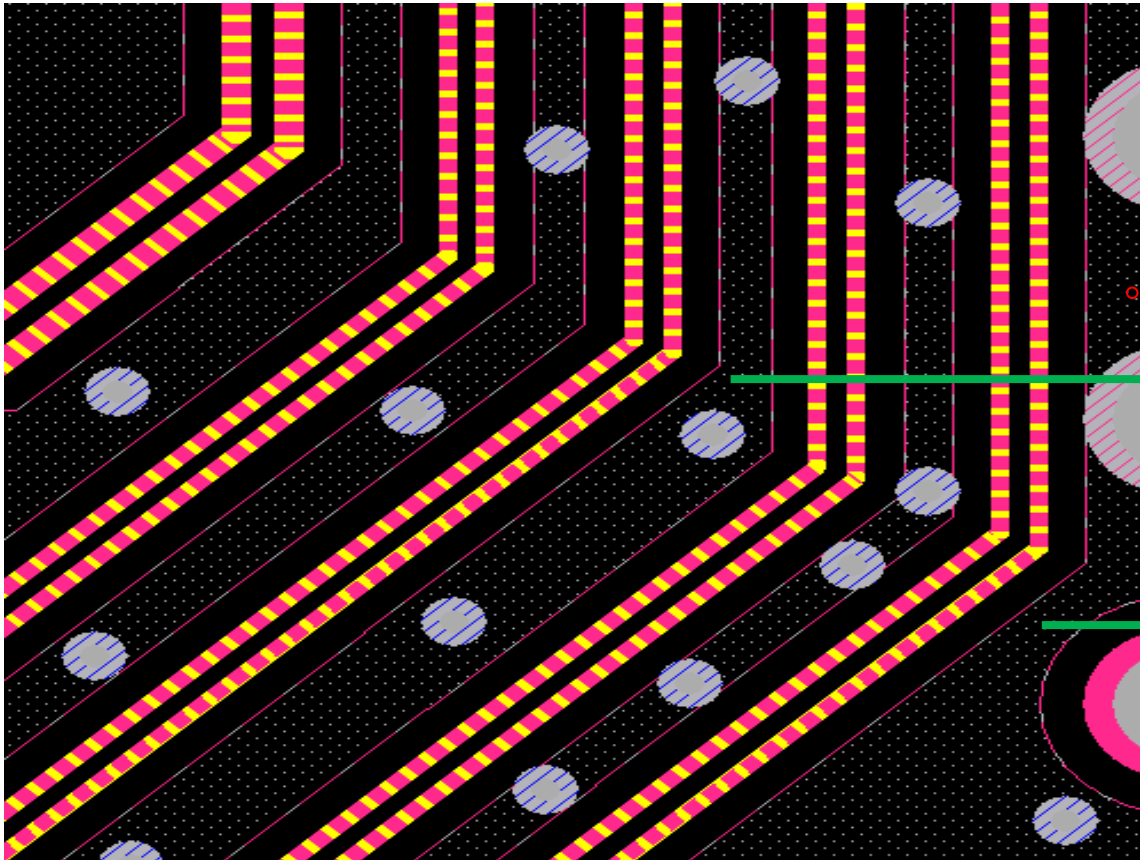

If the audio signal is not grounded, TDD noise will be obvious.

Route traces in groups. Isolate them by via-holes after grounding.

Isolated from other signals

Low Speed Digital Signal (such as UART/JTAG/PCM)

[Other Recommendation1] Low speed digital signals such as UART, SPI, JTAG, I2C, PCM and so on should be separately traced as groups. And isolate the groups by grounding. The distance between the clock signal and other signals should at least is twice the line width span.

[Other Recommendation2] In most area, low speed digital signals need at least one layer of reference ground.

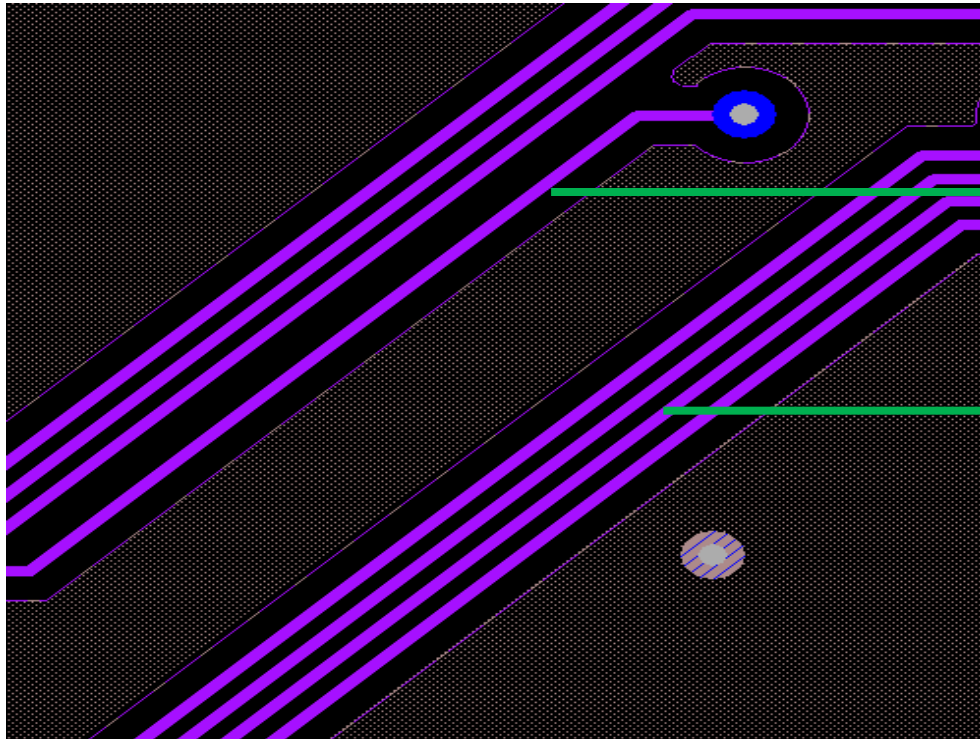

The distance between the clock signal and other signals should at least is twice the line width span.

The same kind of signals are traced as groups.

ESD Protection

[ESD Rule1] The headphone interface, SIM card interface, SD card interface and USB connector all need ESD protection components.

[ESD Rule2] When in PCB layout, place the ESD protection component near the related interface pin. And when tracing, make sure the signal firstly goes through the ESD protection component.

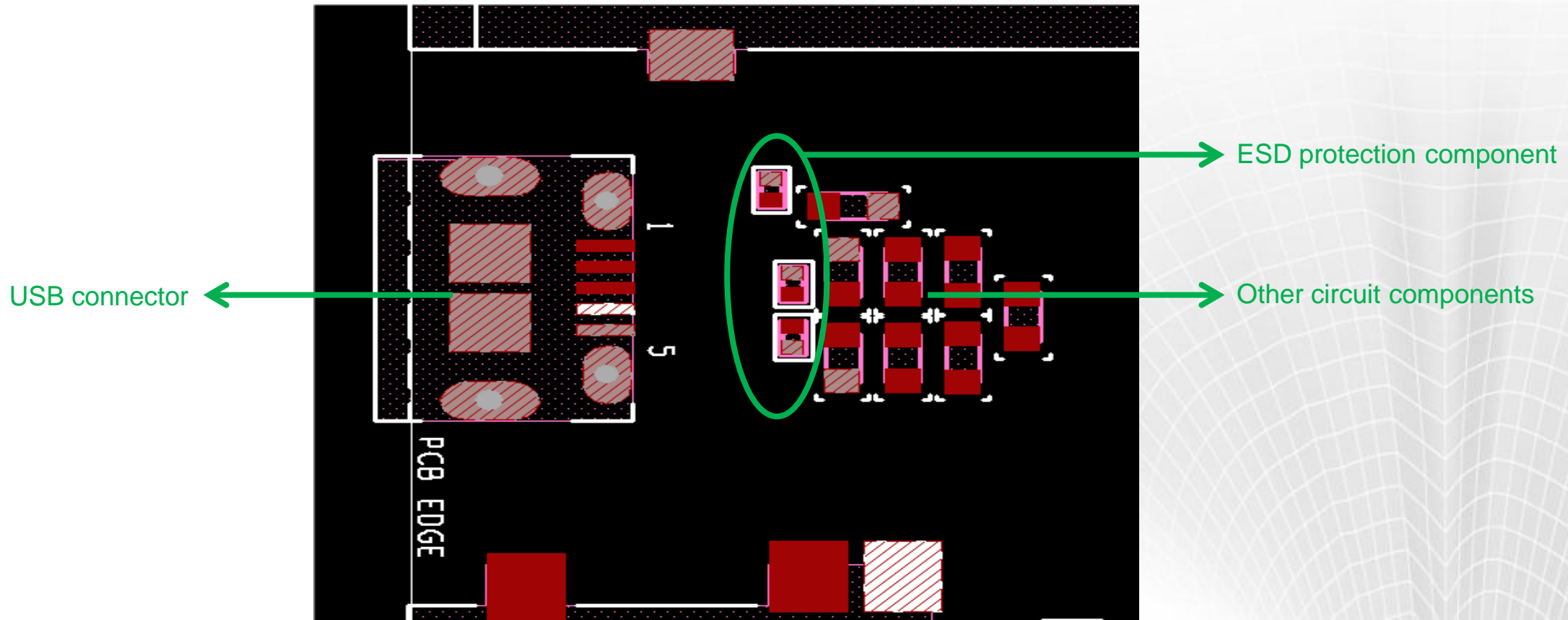

SIM Card Interface

[SIM Rule1] Place ESD protection components near their corresponding pins. If an RC filter is required, place it near the corresponding ESD protection component.

[SIM Recommendation1] The trace of the SIM card interface is 10 cm or shorter.

[SIM Recommendation2] Isolate SIM card signals from other high-speed signals to prevent signal reception of high-speed signals from being affected by the SIM card.

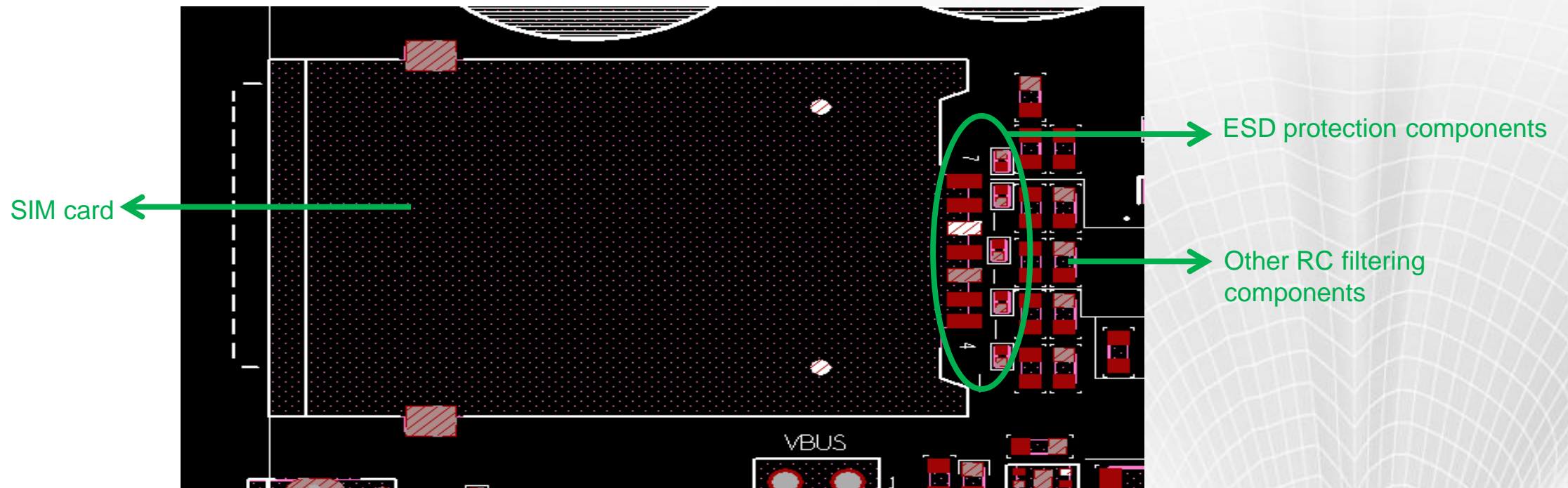

CHECKLIST1

[RF Rule1]	For boards that have more than two layers, empty part of the adjacent layer below the RF pad.
[RF Rule2]	The recommended distance between the RF pad and copper sheet in the same layer is 15 mils.
[RF Rule3]	The impedance of the trace between the RF pad and antenna is 50 ± 5 ohm.
[RF Rule4]	Separate RF signals and other signals using ground copper sheets with holes.
[RF Recommendation1]	Make the trace between the RF pad and antenna (or antenna connector) as short and wide as possible to reduce insertion loss.
[RF Recommendation2]	Route the RF trace along the surface layer to reduce insertion loss.
[RF Recommendation3]	The recommended distance between the RF pad and copper sheet in the same layer is twice the thickness of the medium.
[RF Recommendation4]	The matching components of antenna (or antenna connector) should be placed close to the antenna.
[RF Recommendation5]	For SMA connectors, the distance between the RF pad and surrounding sheet is 100 mils. And the ground holes are well-distributed around.
[Power Recommendation1]	Place small capacitors near power pins as much as possible.
[Power Recommendation2]	40 mils 1 A power traces.
[Power Recommendation3]	Each hole in the power trace allows 0.5 A current.
[Power Recommendation4]	Big power pad traces on the single side, and the width of trace is not wider than that of pad.
[GND Recommendation1]	Use thermal pad connectors for the ground signal pad with connecting cables 10 mils wide to facilitate welding.

CHECKLIST2

[GND Rule1]	Holes are drilled near the thermal pad as much as possible.
[GND Recommendation2]	Use thermal pad connectors for the ground thermal pad with connecting cables 40 mils.
[USB Rule1]	The impedance difference of USB signals is $90 \pm 10\%$ ohm.
[USB Recommendation1]	For boards that have more than two layers, empty part of the adjacent layer below the USB pad.
[USB Recommendation2]	Route the USB trace along the PCB inside to reduce interference to wireless performance.
[USB Recommendation3]	Provide a complete reference ground for USB signals. Drill reflow holes near the interlayer holes. The distance between the USB trace and copper sheet at the same layer is 10 mils.
[Audio Rule1]	Connect audio traces to the ground and route them in groups. Isolate the groups after grounding.
[Audio Rule2]	The audio signal of LGA modules is differential structure, so route the audio trace as differential groups.
Audio Recommendation1]	Route the audio trace away from other digital signals.
[Other Recommendation1]	Low speed digital signals such as UART, SPI, JTAG, I2C, PCM and so on should be separately traced as groups. And isolate the groups by grounding. The distance between the clock signal and other signals should at least is twice the line width span.
[Other Recommendation2]	In most area, low speed digital signals need at least one layer of reference ground.
[ESD Rule1]	The headphone interface, SIM card interface, SD card interface and USB connector all need ESD protection components.
[ESD Rule2]	When in PCB layout, place the ESD protection component near the related interface pin. And when tracing, make sure the signal firstly goes through the ESD protection component.

CHECKLIST3

[SIM Rule1]

Place ESD protection components near their corresponding pins. If an RC filter is required, place it near the corresponding ESD protection component.

[SIM Recommendation1]

The trace of the SIM card interface is 10 cm or shorter.

[SIM Recommendation2]

Isolate SIM card signals from other high-speed signals to prevent signal reception of high-speed signals from being affected by the SIM card.

Thank you

www.huawei.com

Copyright©2015 Huawei Technologies Co., Ltd. All Rights Reserved.

The information in this document may contain predictive statements including, without limitation, statements regarding the future financial and operating results, future product portfolio, new technology, etc. There are a number of factors that could cause actual results and developments to differ materially from those expressed or implied in the predictive statements. Therefore, such information is provided for reference purpose only and constitutes neither an offer nor an acceptance. Huawei may change the information at any time without notice.