

PL-7750BGF

CELLULAR/LTE, 2.4/5.0 GHz ISM and GNSS Screw Mount

Key Features

Cable 1: CELLULAR / LTE

- 698-960 MHz
- 1710-2170 MHz
- 2500-2700 MHz

Cable 2: 2.4/5.0 GHz ISM

- 2410-2490 MHz
- 4920-5925 MHz

Cable 3: GPS/GLONASS/QZSS/Galileo

- 1575-1606 MHz

Screw Mount

Anti-Rotation Mechanism

Ground Plane Dependent

Customizable Cable and Connector

Dimensions: Ø 60 x 69 mm



1. Antenna Description

PL77xxB “The Shaker Series”

The World First Solution in its category

With a 3-in-1 architecture design, this unique antenna is the world first solution integrating LTE MIMO in a Shaker Radome configuration. The *PL77xxB* uses the latest antenna technologies that improve signal strength and connectivity in the most dynamic environments. This patented low power consumption and low noise figure architecture design outperforms the competition alternatives in quality, connectivity and reliability while providing increased data throughput.

Flexibility and options

The main 3-in-1 configuration antenna is designed to work with LTE, 2.4/5.0GHz, LTE-MIMO plus GNSS technologies such as GPS, Glonass, Galileo and QZSS for better geolocation and precise tracking. All GNSS options include high rejection SAW filter technology, protecting against LNA burn-out. The same footprint is available in 3-in-1, 2-in-1 and 1-in-1 configurations. This module also comes with multiple options of antenna elements, to allow for different communication technologies and standards to perform with worldwide networks bands such as 433 MHz, 868 MHz, and 915 MHz. These configuration options provide our consumers with more freedom for various custom designs.

Customization options include a fully adjustable cable length and connector type along with a standard RF cable or low-loss cable to improve the overall reception and range. Feel free to refer to our website or contact the sales team for more information on the *PL77xxB* “The Shaker Series”

Typical applications

- Infotainment systems
- WiFi hotspot
- HD video transmission
- Dash cameras
- Connected cars
- Self-driving cars
- Fleet management
- Gateways
- Routers
- Public transportation
- Logistics
- And others

Compatibility Standards

LTE Cables

- CAT 1 2 3 4 5 6 7 8 9 10 11 12
- NB-IoT, LTE-NB1, CAT-M1, CAT-M2
- WCDMA, UMTS, HSPA, EDGE GRPS, GSM, CDMA

2.4/5.0 Cables

- WiFi, Bluetooth, BLE, ISM
- DSRC, V2V, V2X
- Sigfox, LoRa, ZigBee, RPMA, LPWAN

GPS/GLO Cable

- GPS, GLONASS
- Galileo, QZSS, L1, E1

Installation and Durability

The Shaker Series antennas are engineered to work with multiple mounting options, such as Magnetic Mount, Screw Mount, and Adhesive Mount. This series is the only solution available on the market that offers mounting capabilities for the non-magnetized and magnetic metal surface as well through an optional sticky pad.

With the implemented IP67 and IP69K ingress ratings and high-grade UV stable plastic, this compact antenna provides maximum protection against dust and water penetration. To add to its durability, this antenna offers an extra level of anti-vandal security and high impact proof from the IK09 rating resistance.

2. Antenna and electrical specifications

Cable 1

Parameters	CELLULAR / LTE Antenna		
Standards	2G,3G and 4G		
Band (MHz)	700/850/900	1700/1800/1900/2100	2600
Frequency (MHz)	698-960	1710-2170	2500-2700
Return Loss (dB)	~-9.4	~-16.0	~-13.1
VSWR	~2.2:1	~1.4:1	~1.6:1
Efficiency (%)	~67.0	~65.5	~50.0
Peak Gain (dBi)	~2.0	~4.5	~3.7
Average Gain (dB)	~-1.8	~-1.9	~-3.1
Impedance (Ohm)	50		
Polarisation	Linear		
Radiation Pattern	Omni-Directional		
Max. Input Power (W)	25		
Connector Type	SMA-Male Standard (Other Connectors Available)		
Cable Length	300 cm Standard (Any Cable Length Available)		
Cable Type	LMR100 Standard (Other Cables Available)		

Cable 2

Parameters	2.4/5.0 GHz ISM Antenna	
Standards	WiFi, BT, ZigBee, ISM	
Band (MHz)	2.4 GHz	5.0 GHz
Frequency (MHz)	2410-2490	4920-5925
Return Loss (dB)	~-13.3	~-7.4
VSWR	~1.5:1	~2.5:1
Efficiency (%)	~60.1	~31.4
Peak Gain (dBi)	~4.5	~2.5
Average Gain (dB)	~-2.2	~-5.0
Impedance (Ohm)	50	
Polarisation	Linear	
Radiation Pattern	Omni-Directional	
Max. Input Power (W)	25	
Connector Type	RP-SMA-Male Standard (Other Connectors Available)	
Cable Length	300 cm Standard (Any Cable Length Available)	
Cable Type	LMR100 Standard (Other Cables Available)	

Antenna Measurement Conditions:

Mounted on 30 x 30 cm Ground Plane

200 cm of Cable LMR100

Measured in Certified CTIA 3D Anechoic Chamber

Cable 3

Parameters	GPS/GLONASS Antenna	
	GPS/QZSS/Galileo	GLONASS
Standard		
Band (MHz)	1575	1602
Frequency(MHz)	1575.42	1598-1606
Patch Size (mm)	25 x 25 x 4	
Return Loss (dB)	<=-15.0 dB	
VSWR	<=1.4:1 dB	
Impedance	50	
Radiation Pattern	Hemispherical	
Polarization	RHCP	
Saw Filter	Pre-filter	
Active Gain (dB)	28 @ 2.7 V	
Noise Figure (dB)	1.5 Typ	
Voltage (V)	1.5 – 3.6	
Current (mA)	9 Typ	
Power Consumption (mW)	24.3 Typ	
ESD Protection (kV)	2kV	
Connector Type	SMA-Male Standard (Other Connectors Available)	
Cable Length	300 cm Standard (Any Cable Length Available)	
Cable Type	LMR100 Standard (Other Cables Available)	

3. Mechanical and environmental specifications

Specifications	PL7750BGF
Mounting Type	Screw Mount
Dimensions (mm)	Ø 60 x 69
Radome Type	PC/ABS UV Stable
Radome Color	Black
Antenna Base	Zamak
Gasket	TPE
Operating Temperature (C)	-40 to +85
Storage Temperature (C)	-40 to +85
Substance Compliance	RoHS

4. Antenna parameters

Table 1: CELLULAR/LTE

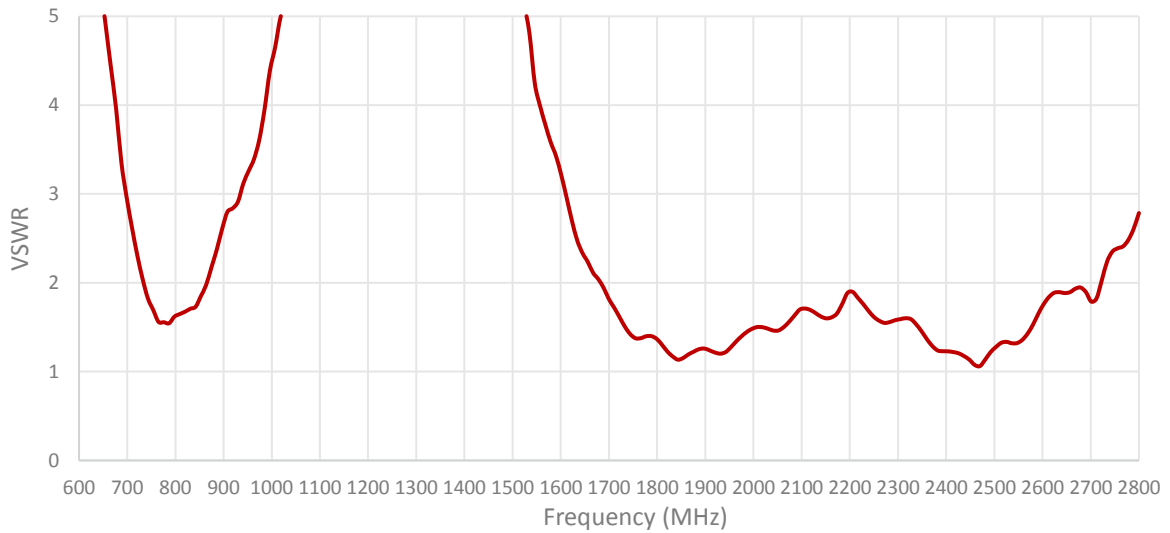
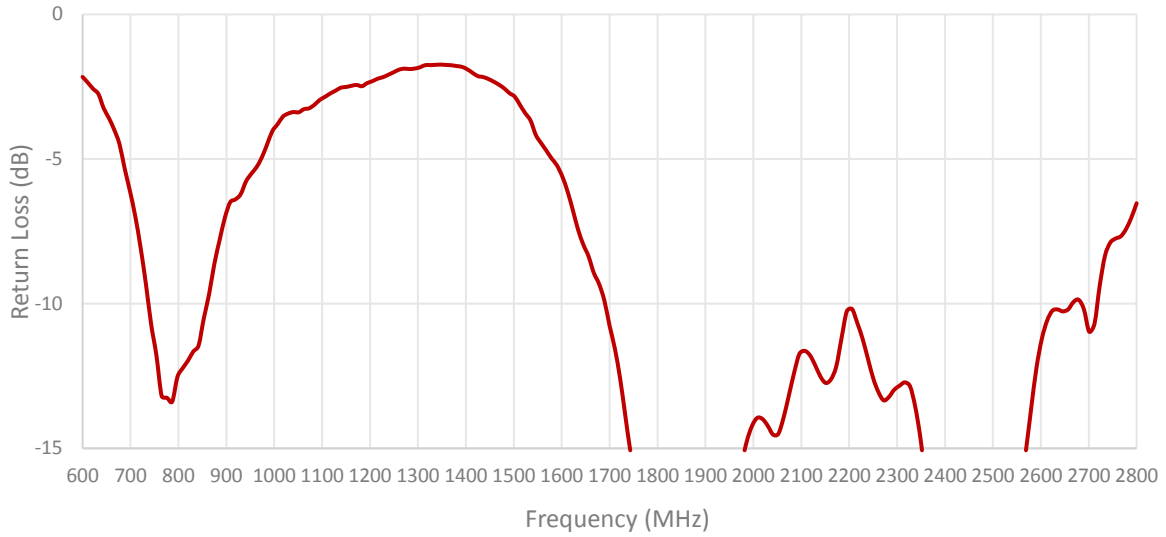

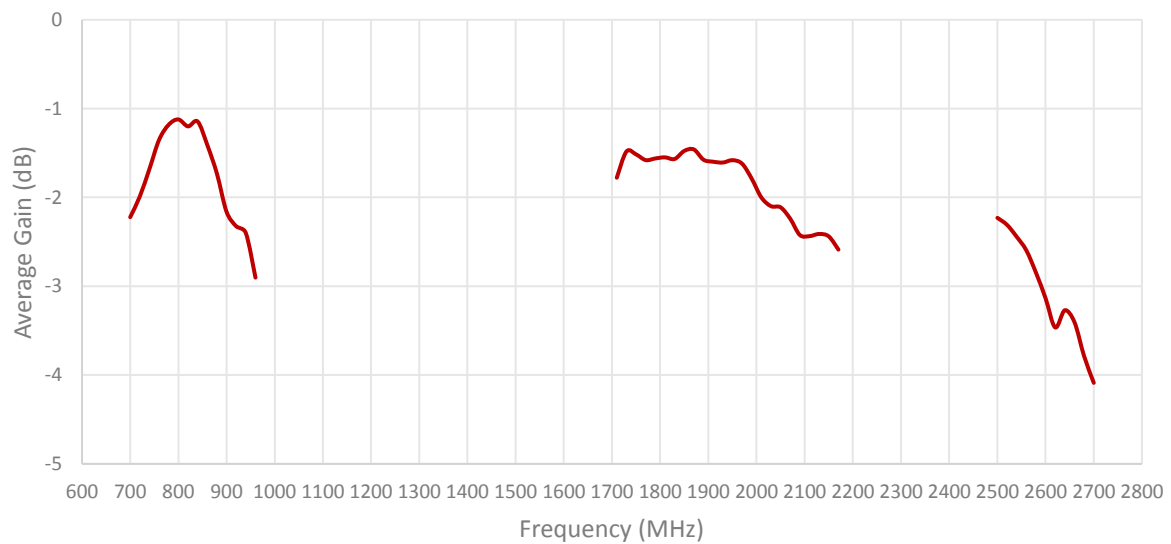
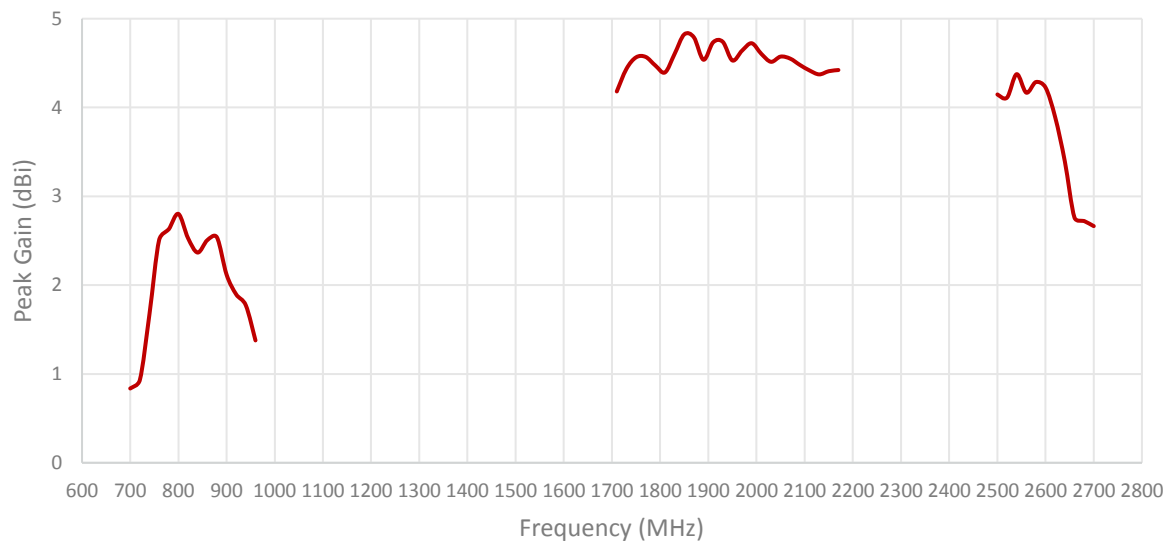
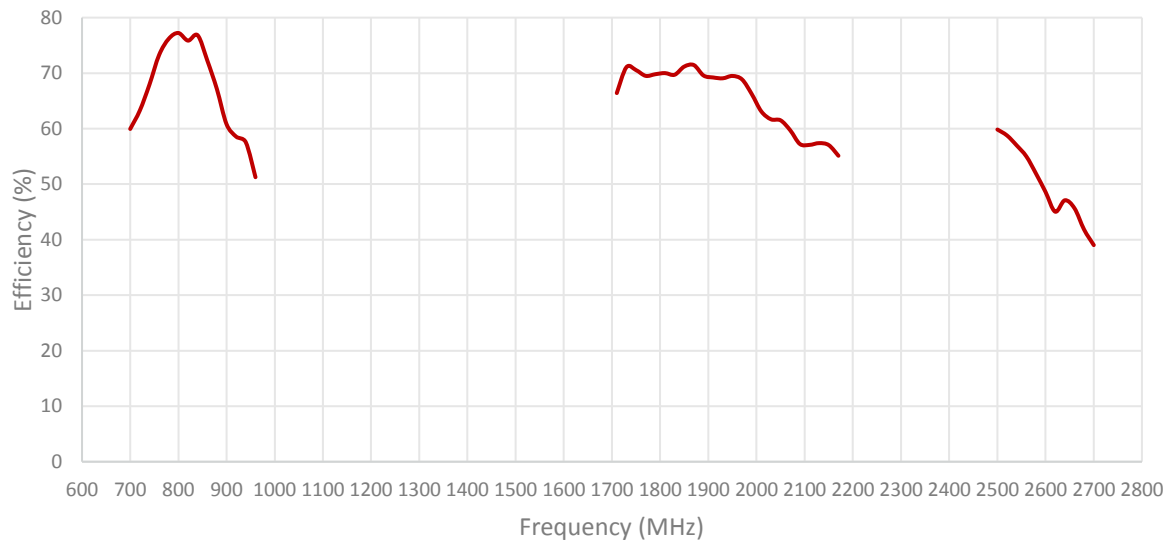

Cable 2: 2.4/5.0 GHz ISM

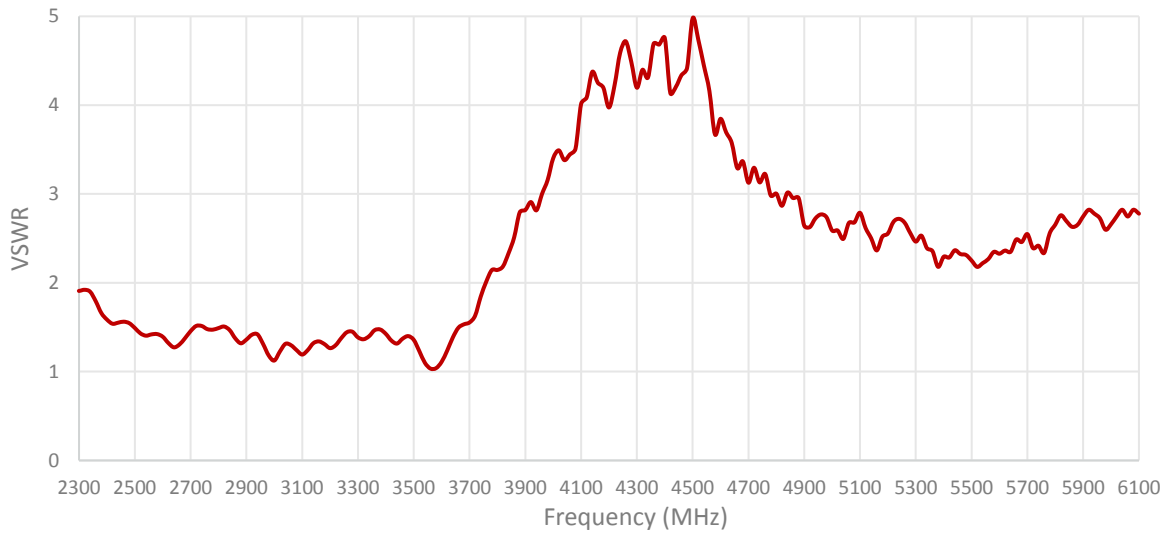
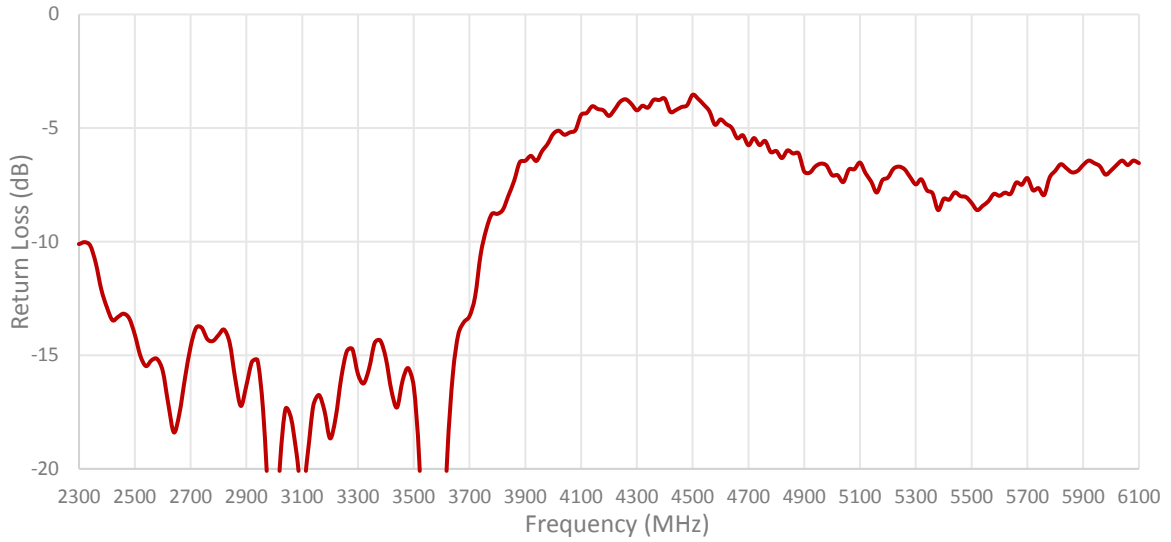

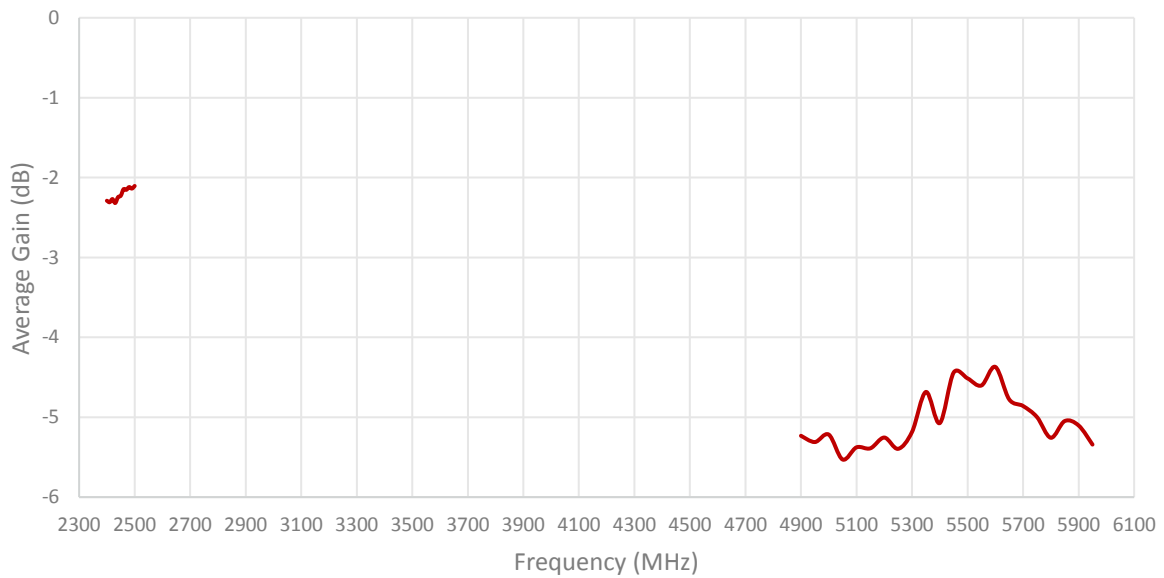
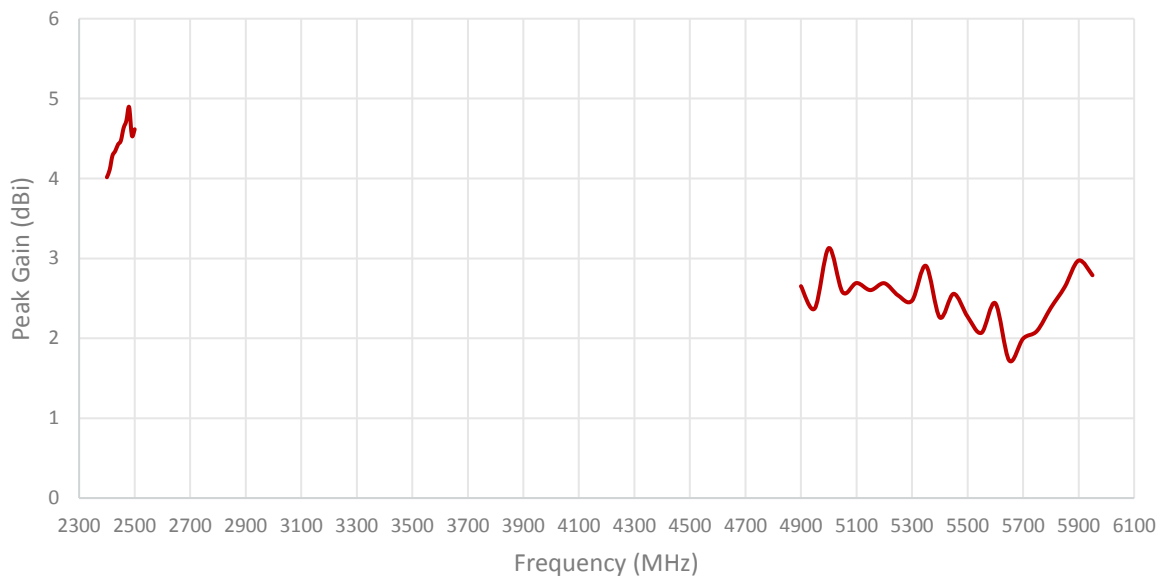
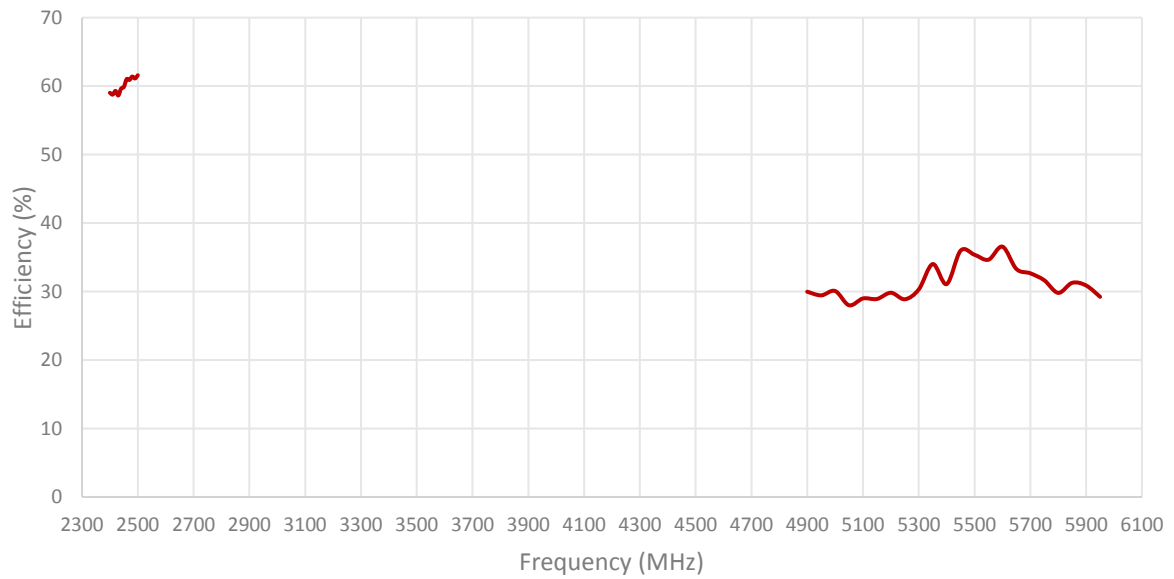

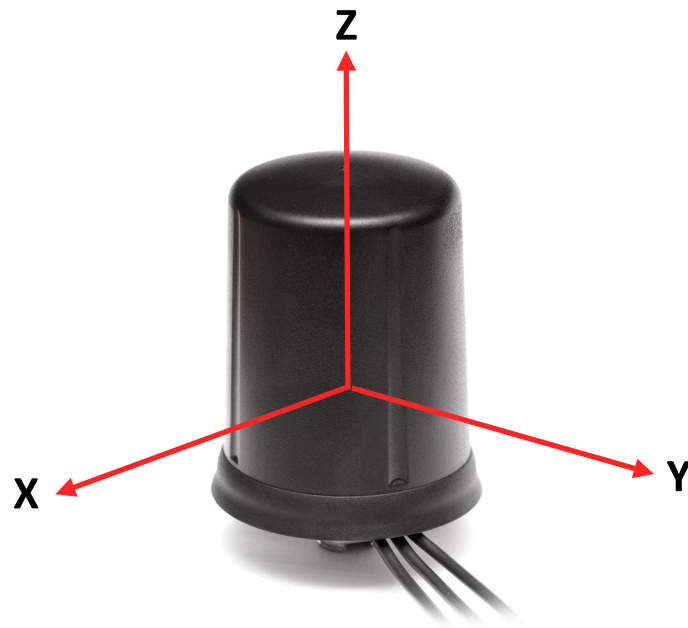

Radiation pattern reference

Table 1: CELLULAR/LTE

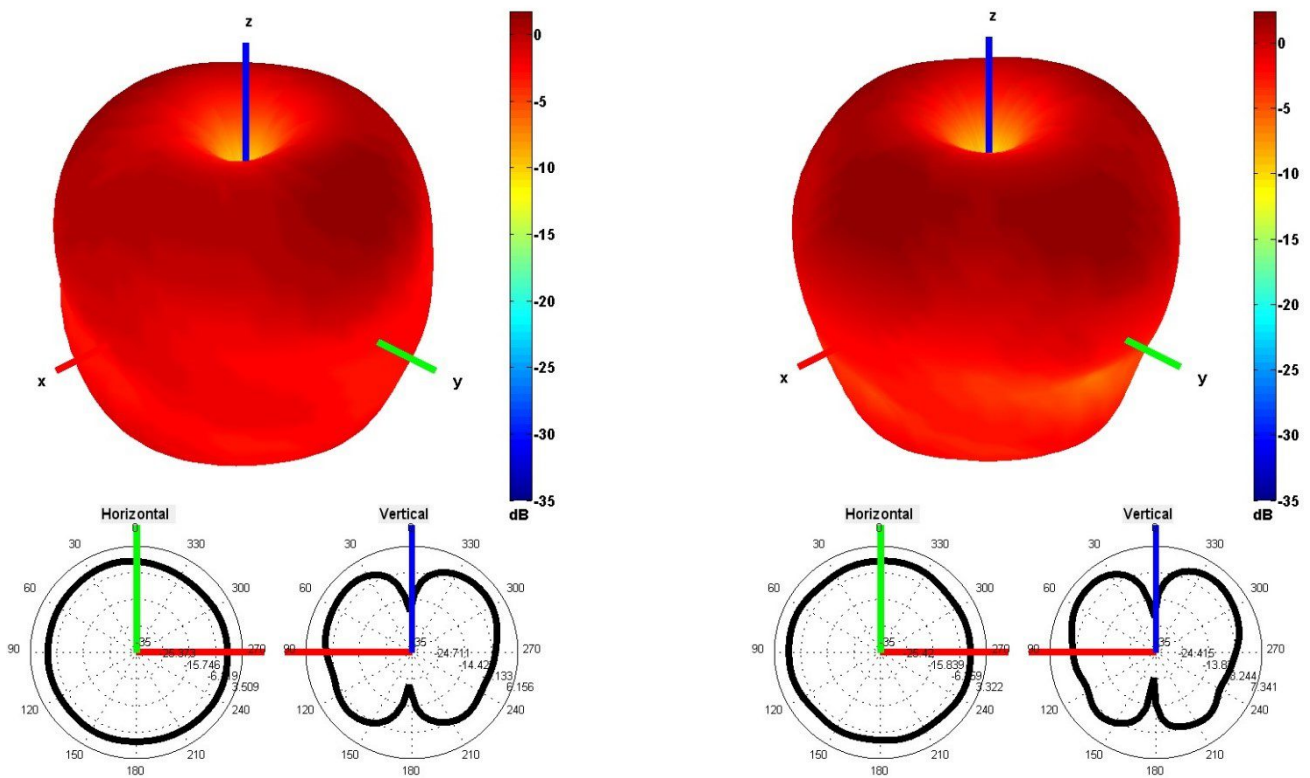

750 and 850 MHz Radiation pattern

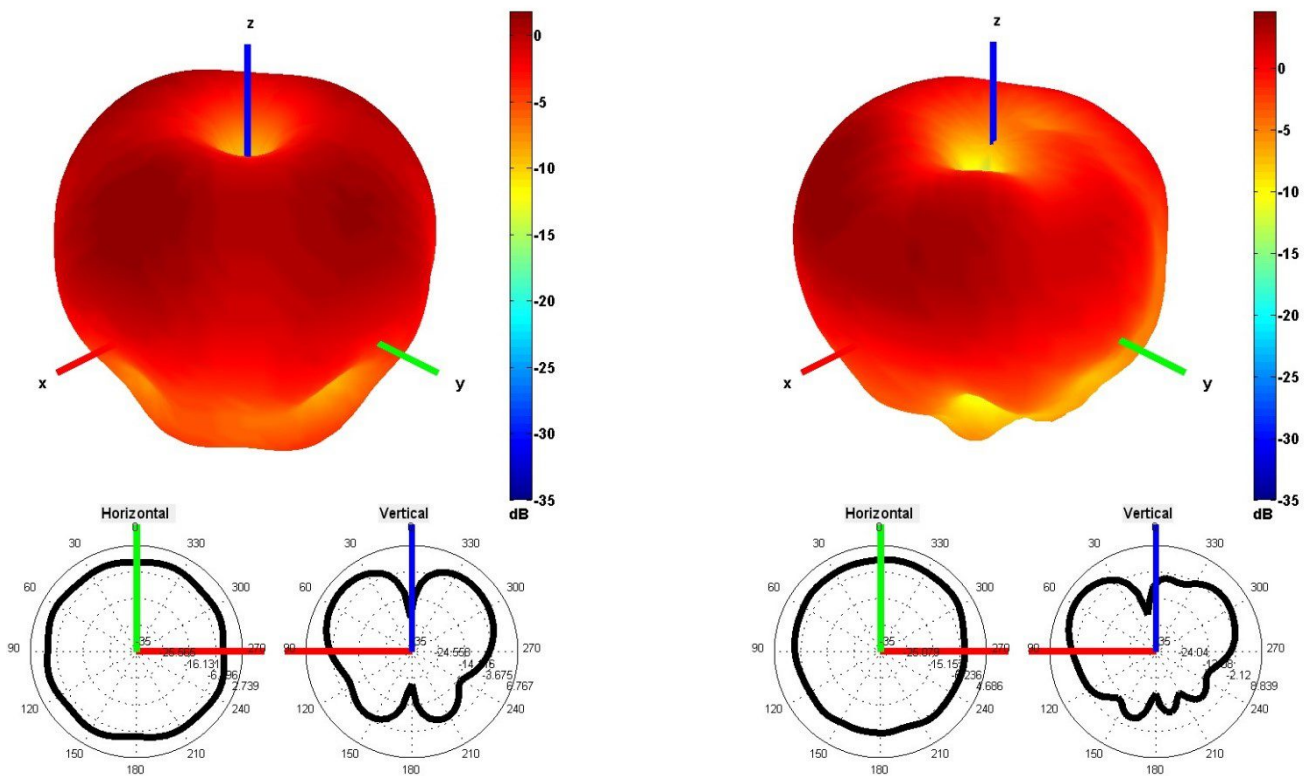

940 and 1750 MHz Radiation pattern

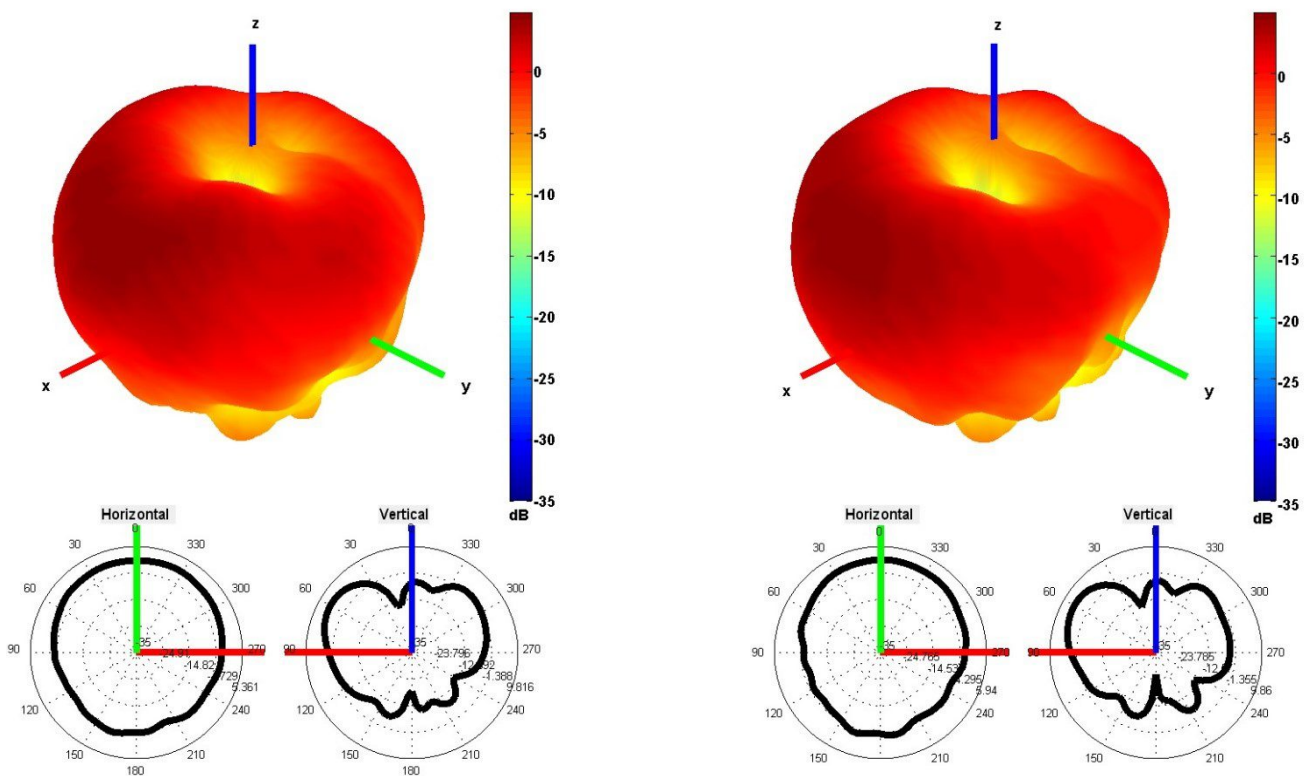

1850 and 1950 MHz Radiation pattern

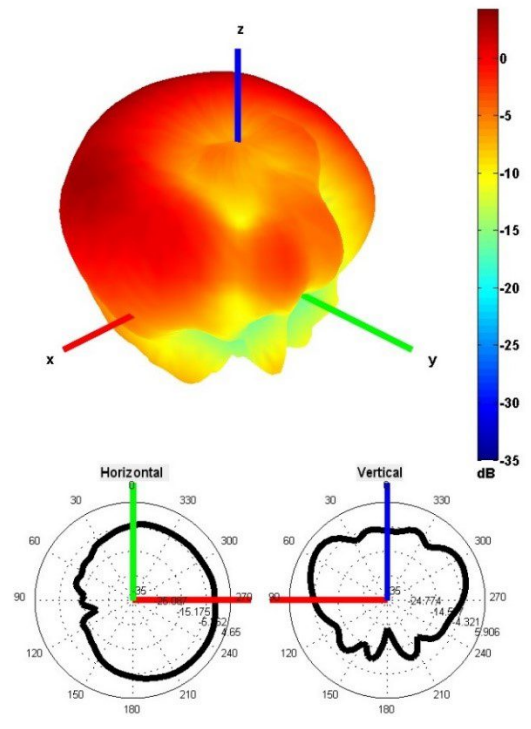
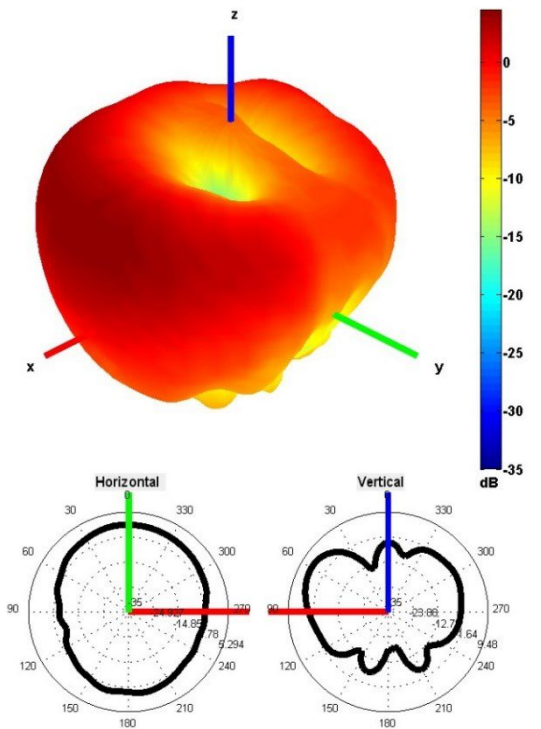

2100 and 2600 MHz Radiation pattern

Table 2: 2.4/5.0 GHz ISM

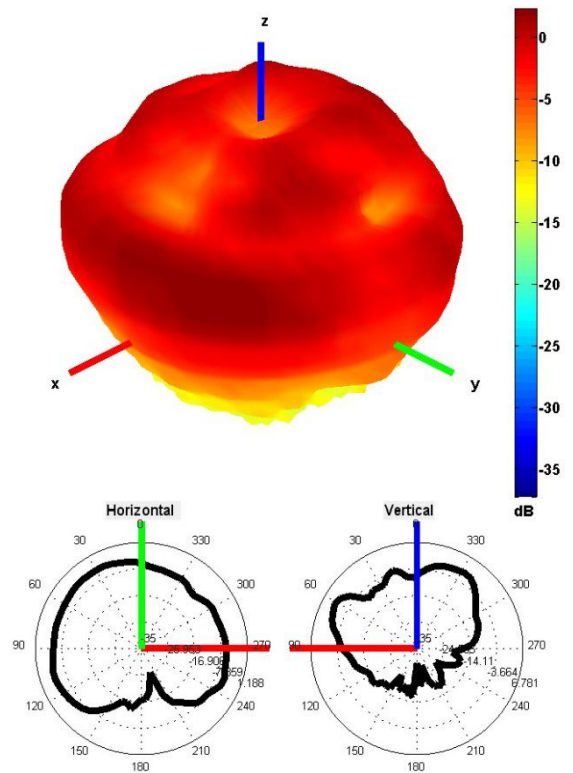
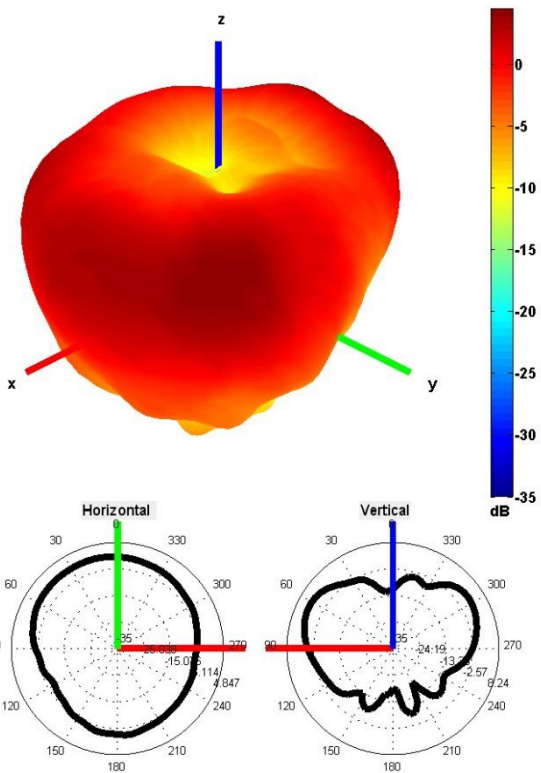

2450 and 5500 MHz Radiation pattern

5. Antenna drawings

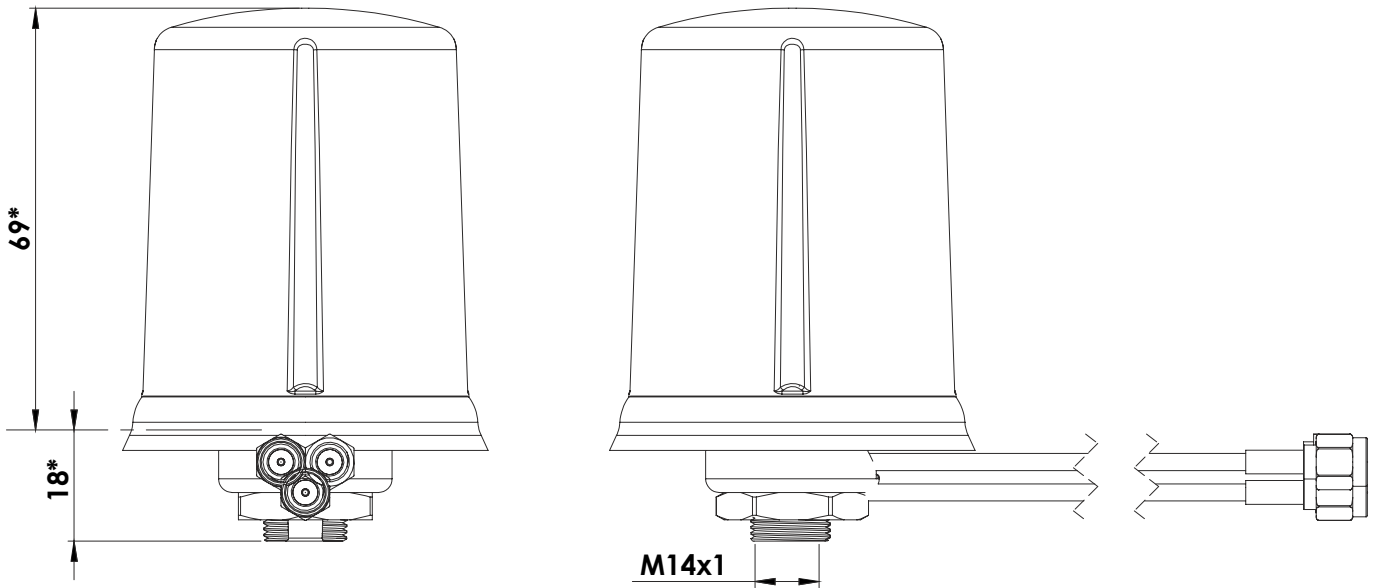

* Dimensions after mounting

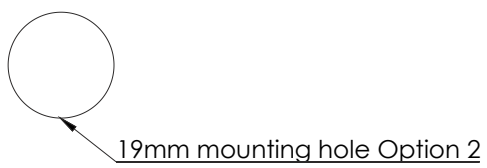
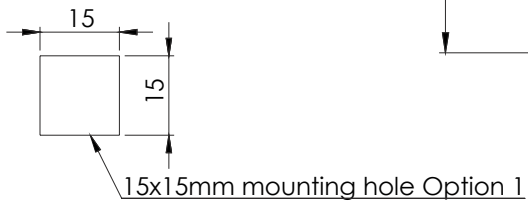
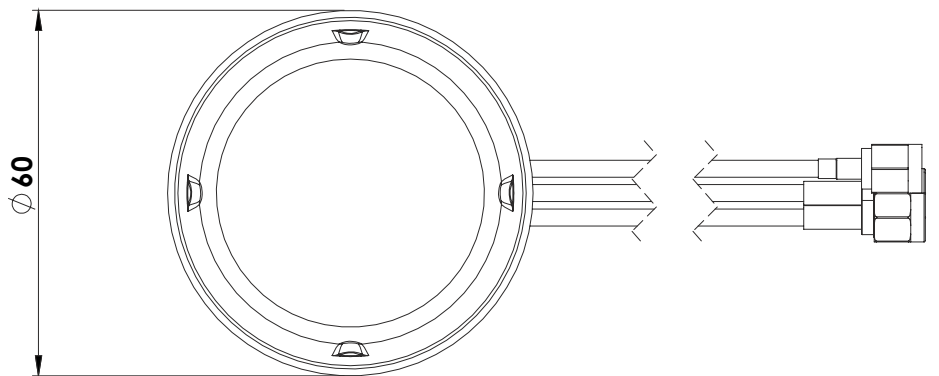

6. Antenna Images

